



AQR S3 Omni® Series Upgrade Kit

Owner's Manual



Contents

- Before You Begin.....2
- Installing the Kit.....5
- Electrical.....9
- System Startup.....14
- Configuration.....15
- Warranty.....50

Hayward Industries
 1415 Vantage Park Dr., Suite 400
 Charlotte, NC 28203
 Téléphone : (908) 355-7995
www.hayward.com



HAYWARD®

IMPORTANT SAFETY INSTRUCTIONS

When using this electrical equipment, basic safety precautions should always be followed, including the following:

- **READ AND FOLLOW ALL INSTRUCTIONS**
- Use Copper Conductors Only
- Disconnect all AC power during installation.
- Warning - To reduce the risk of injury, do not permit children to use this product unless they are closely supervised at all times.
- Hayward salt systems are designed, tested and sold as systems and are certified by several agencies around the globe --- with each component of the systems meeting all required certifications and attendant legal requirements. The use of an untested, uncertified generic cells (or generic circuit boards) with Genuine Hayward salt chlorination products could lead to premature product failure.
- Pursuant to the terms and conditions of any applicable Warranty, the use of a non-genuine Hayward replacement salt chlorination cell on any Hayward automation or chlorination product will void any Warranty.
- A green colored terminal is located inside the wiring compartment. To reduce the risk of electric shock, this terminal must be connected to the grounding means provided in the electric supply service panel with a continuous copper wire equivalent in size to the circuit conductors supplying the equipment.
- All field installed metal components such as rails, ladders, drains, or other similar hardware within 3 meters of the pool, spa or hot tub shall be bonded to the equipment grounding bus with copper conductors not smaller than 8 AWG US / 6 AWG Canada.
- **NOTICE TO USERS:** This control product is to be used only in accordance with the directions of this label. It is an offense under the Pest Control Products Act to use a control product under unsafe conditions.

SAVE THESE INSTRUCTIONS

FCC Statement

This device complies with part 15 of the FCC rules. Operation is subject to the following two conditions: (1) This device may not cause harmful interference, and (2) this device must accept any interference received, including interference that may cause undesired operation.

Changes or modifications not expressly approved by Hayward could void the user's authority to operate this equipment.

NOTE: This equipment has been tested and found to comply with the limits for a Class B digital device, pursuant to Part 15 of the FCC Rules. These limits are designed to provide reasonable protection against harmful interference in a residential installation. This equipment generates, uses and can radiate radio frequency energy and, if not installed and used in accordance with the instructions, may cause harmful interference to radio communications. However, there is no guarantee that interference will not occur in a particular installation. If this equipment does cause harmful interference to radio or television reception, which can be determined by turning the equipment off and on, the user is encouraged to try to correct the interference by one or more of the following measures:



HAYWARD®

- Reorient or relocate the receiving antenna.
- Increase the separation between the equipment and receiver.
- Connect the equipment into an outlet on a circuit different from that to which the receiver is connected.
- Consult the dealer or an experienced radio / TV technician for help.

Industry Canada Statement

This Class B digital apparatus complies with Canadian ICES-003.

Cet appareil numérique de la classe B est conforme à la norme NMB-003 du Canada.

The term "IC" before the certification / registration number only signifies that the Industry Canada technical specifications were met.

Before you Begin

The AQR S3 Omni® Upgrade Kit will upgrade your AQR S3 chlorinator to a fully web enabled pool automation control while preserving the chlorine generation features. Automatically and remotely control pumps, heaters, valve actuators, pool and yard lighting, pool chemistry equipment and more. The upgraded "AQR S3 Omni" offers the next generation of technology to manage pool/spa equipment, allowing communication to web connected computers, tablets and mobile devices. Using the touchscreen interface or web connected devices, you can now conveniently monitor your pool/spa and change settings anytime, and from anywhere.

Compatibility

The Hayward AQR S3 Upgrade Kit is only compatible with the AQR S3 chlorinator. This manual assumes that the AQR S3 has already been installed and is wired to existing pool equipment. Any current configured equipment, timers and settings will be lost after upgrading. It's important to capture all of this information before starting the installation.

This upgrade will convert the AQR S3 to the Omni family of products and is only compatible with Omni specific accessories. A list of Omni accessories are shown on the following page.

HLWIRELESS	Portable Wireless Remote Terminal
HLSPASIDE	Wired Spa Remote
HL-CHEM	ORP & pH Sensing Kit for monitoring and controlling pool chemistry

NOTE: For systems using a Hayward EcoStar VSP running firmware version less than R3.0.5 (pumps built before 2014), a Hayward SPX3400LCD display must be purchased and installed on the EcoStar pump if variable speed operation is desired with the AQR S3 Omni. If single speed control is desired, no changes are necessary.

Features

The upgraded AQR S3 Omni offers the following features:

- can generate chlorine using a range of salt concentrations from between 2700 – 3400 PPM (Standard Salt mode) or 1200-1800 PPM (Low Salt mode)
- control and schedule a Hayward Variable Speed (VSP) pump using the internal RS-485 connection, a Pentair VSP using a Hayward HLPMPCONV converter (sold separately) or a single speed pump using an internal relay
- connection for pool cover detection (lowers chlorine production when the pool is covered)



HAYWARD®

- can be powered by either 115 or 230 VAC
- offers recirculation freeze control which turns on the filter pump automatically to prevent freezing
- offers 2 high voltage (120/240V) internal relays to control pumps, pool lights, yard lights, water features, chemical dispensers and more (an additional external Smart Relay can be added for up to 3 high voltage relays)
- control up to 2 automatic valve actuators including pool and spa valves, water feature valves, cleaner valves and more
- control up to 2 heaters or low voltage equipment including gas heaters, electric heat pumps, and solar heaters as well as various low voltage devices
- up to 4 external inputs; 3 for temperature sensing, 1 for pool cover detection
- built-in wireless and Ethernet port for connection to the home's router/access point allowing communication to devices on the home network or on the web
- input for flow switch for water flow detection
- BNC inputs for ORP and pH sensing
- control an optional AQR S3 chlorinator or a Hayward AquaRite salt chlorinator for additional chlorination (the AquaRite must have a HLAQRPCB communication board installed)

What's Included

Along with some fasteners, check that the following components have been included in the package:

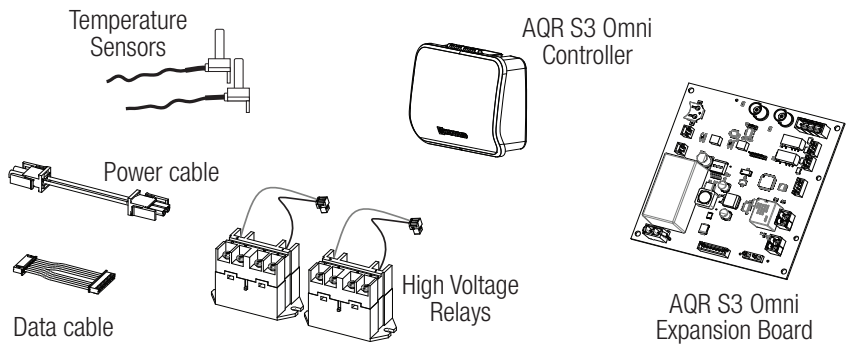

What's NOT Included

Some of the additional items that you may need to complete an installation include:

- Wire/conduit to additional pool equipment that will be controlled by the AQR S3 Omni
- Hayward Smart Relay - a single Smart Relay can be added for additional high voltage pool equipment

The functions and features described in this manual assume that the upgraded AQR S3 Omni is using the latest firmware version available from Hayward. For instructions on how to upgrade firmware, refer to AQR S3 Omni Operation manual.

Record the AQR S3's Configuration, Settings and Timer Information

Because all settings will be lost after upgrading, you may want to go through the AQR S3 menu and write down any of the current schedules, heater temperatures, pump speeds, chlorinator settings, etc. A worksheet is available on the following page and will aid in recording the current pool settings. These values will all need to be entered after the upgrade when configuring the AQR S3 Omni.



AQR S3 Worksheet

Chlorination	<input type="checkbox"/> Enabled <input type="checkbox"/> Disabled
Level	____%
Filter Pump	On Off
Speed	<input type="checkbox"/> Low <input type="checkbox"/> Medium <input type="checkbox"/> High
Schedule	<input type="checkbox"/> Enabled <input type="checkbox"/> Disabled
Speed 1	<input type="checkbox"/> Low <input type="checkbox"/> Medium <input type="checkbox"/> High
Speed 2	<input type="checkbox"/> Low <input type="checkbox"/> Medium <input type="checkbox"/> High
Speed 3	<input type="checkbox"/> Low <input type="checkbox"/> Medium <input type="checkbox"/> High
Speed 1	____:____ ^{AM} / _{PM} to ____:____ ^{AM} / _{PM}
Speed 2	____:____ ^{AM} / _{PM} to ____:____ ^{AM} / _{PM}
Speed 3	____:____ ^{AM} / _{PM} to ____:____ ^{AM} / _{PM}
Heating	<input type="checkbox"/> Enabled <input type="checkbox"/> Disabled
Temperature	____ <input type="checkbox"/> °F <input type="checkbox"/> °C
Speed	<input type="checkbox"/> Low <input type="checkbox"/> Medium <input type="checkbox"/> High <input type="checkbox"/> Scheduled
Heater Ext.	<input type="checkbox"/> Enabled <input type="checkbox"/> Disabled
Cool Down	<input type="checkbox"/> Enabled <input type="checkbox"/> Disabled
Pool Cover	<input type="checkbox"/> Enabled <input type="checkbox"/> Disabled
Chlorination	____%
Pump	<input type="checkbox"/> Enabled <input type="checkbox"/> Disabled
Speed	<input type="checkbox"/> Low <input type="checkbox"/> Medium <input type="checkbox"/> High <input type="checkbox"/> Scheduled
Service Mode	
Cell Type	<input type="checkbox"/> T-Cell-S315 <input type="checkbox"/> T-Cell-S325 <input type="checkbox"/> T-Cell-S345
Filter Pump	Low ____% Medium ____% High ____% Freeze Prot. ____%



Installing the Upgrade Kit

Thoroughly read through this manual before attempting to install, configure and operate the unit.

Front Panel Removal

DANGER of Death, Injury or Property Damage if procedure not followed. Dead front panel removal is required for this installation. Power to the AQR S3 **MUST** be shut off before the dead front panel is removed. After removing the panel, disconnect the display from the circuit board and put it aside.

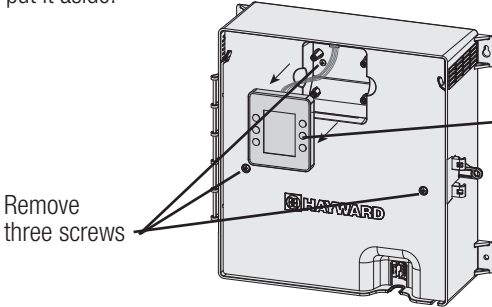

Pull the display away from the panel by grasping it with your hand (no tools required). Then, remove the 3 screws and pull the plastic deadfront panel away from the enclosure. It is not necessary to disconnect the display wiring from the board but may offer more room to work.

Install the AQR S3 Omni Expansion Board

Before installing the AQR S3 Omni Expansion board, determine if your unit has a green grounding cable shown in Figure 1 below. If there is no green grounding cable, proceed with the directions below ignoring any references to the cable.

If your unit has a green grounding cable, remove it now. Position the AQR S3 Omni Expansion Board as shown in Figure 2, reattach the cable and then fasten using the 4 supplied screws. The AQR S3 Omni Expansion Board should be oriented so that power and data cable connections are next to the matching connectors on the AQR S3 Mainboard. The green ground cable will reattach to the top left as show.

Detach green ground cable before installing new Expansion Board

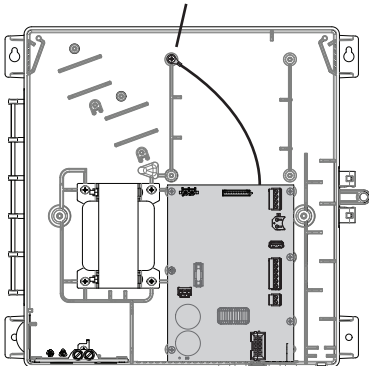

Figure 1

Install AQR S3 Omni Expansion Board
Reattach green cable here

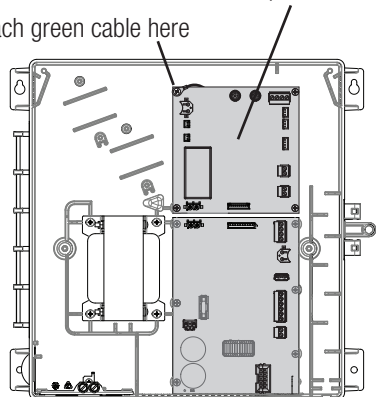

Figure 2



HAYWARD®

Install the Power and Data Cables

Connect the AQR S3 Omni Expansion Board to the original AQR S3 board using the cables below.

Plug in the power cable connecting the two boards. Be aware of orientation as the connectors will only insert one way.



Plug in the data cable. One connector is larger than the other. Be aware of orientation as the connectors will only insert one way.

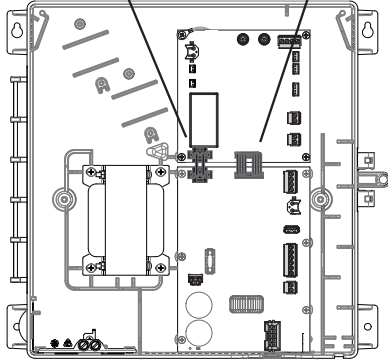

Attach Wire Harness to Relays

Before installing the relays, attach the relay wire harnesses.

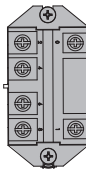
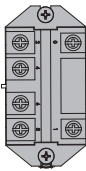

Loosen both coil side relay screws and secure the fork terminal connectors as shown



HAYWARD®

Installing the High Voltage Relays

Use the supplied fasteners to install the relays into the enclosure. After installing the relays, plug the wire harness into the AQR S3 Omni Expansion Board as shown below.

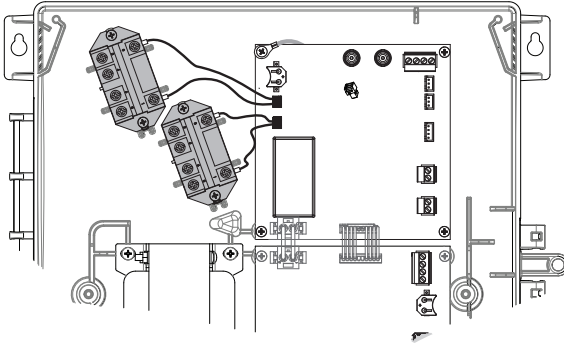

AQR S3 Omni Controller

The Controller comes with a 15ft (4.6m) cord and plugs into the AQR S3 Omni. Because it plugs into the AQR S3 Omni Expansion Board, it should be mounted close by, but in a location that is convenient for the user to periodically view and change pool/spa settings. The Controller contains the wifi radio and its location should be considered if planning to use a wireless connection to the home router or access point. A wireless mobile device (phone, tablet, etc.) could be used to test the signal strength at the intended mounting location. The Controller features a USB connector for firmware updates and logging feature as well as an Ethernet connector for optional direct wire connection to your router if wifi won't or can't be used.

When considering the mounting location, make sure there is enough clearance above the Controller so that the flip door will be able to be opened fully. Also be sure to allow enough clearance below the Controller to access the Ethernet connector if used. For best viewing results, position the Controller where it won't be subjected to direct sunlight.

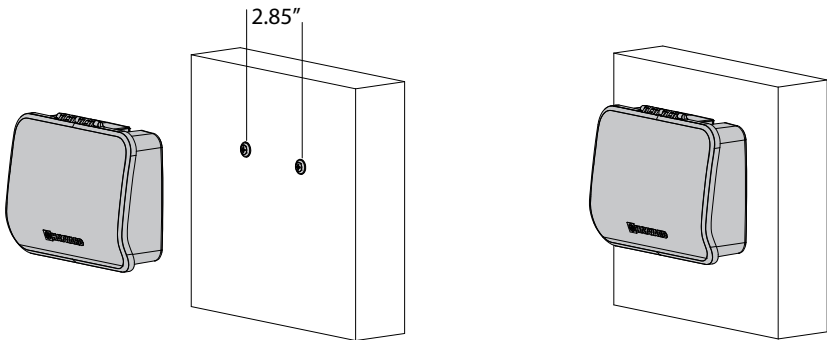



HAYWARD®

The Controller has two keyhole cutouts on the back of its enclosure. A mounting template is provided on page 46. To mount, screw two appropriate fasteners into the mounting surface at the desired location as shown below. Tighten until the bottom of the screw heads are 1/8" off the mounting surface. Position the Controller cutouts over the screw and slide the unit downward. You may have to tighten or loosen the screws slightly to fully engage the screw heads to get a snug fit.

Connect the controller to the AQR S3 Omni Expansion Board as shown below.

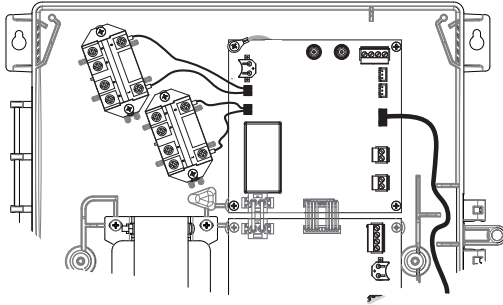

Temperature Sensors

The AQR S3 Omni is packaged with two temperature sensors, one for water and one for air.

Water Sensor

This sensor measures the pool/spa temperature and is used for heating. It is installed in the filtration plumbing after the filter but before either the solar or conventionally fueled heaters.

1. Drill a 3/8" (10mm) diameter hole in the PVC piping and remove all chips and burrs.
2. Insert sensor until O-ring collar sits flush on the hole.
3. Position hose clamp over the sensor and gently tighten until O-ring makes an adequate seal. Do not overtighten.

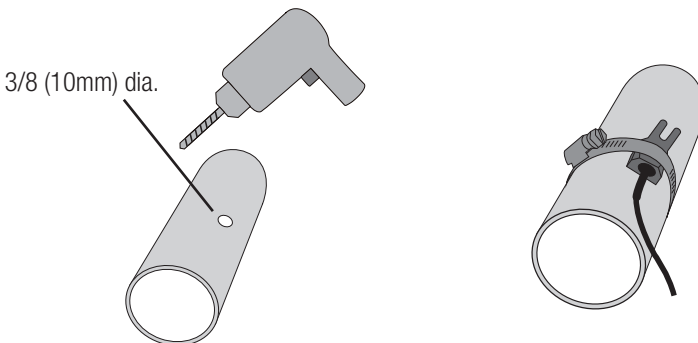

Air Sensor

This sensor is used to provide recirculation freeze protection. Mount the air sensor outdoors in a space that is not in direct sunlight or subject to heating/cooling from other sources.



Electrical

Now that the upgrade kit is fully installed, any new equipment should be connected before the AQR S3 Omni is configured. All the current wiring connections from the AQR S3 can remain and there is no need to rewire any of the existing connections from your pool equipment. The information on the following pages will supplement the wiring section in the original AQR S3 if more equipment will be added.

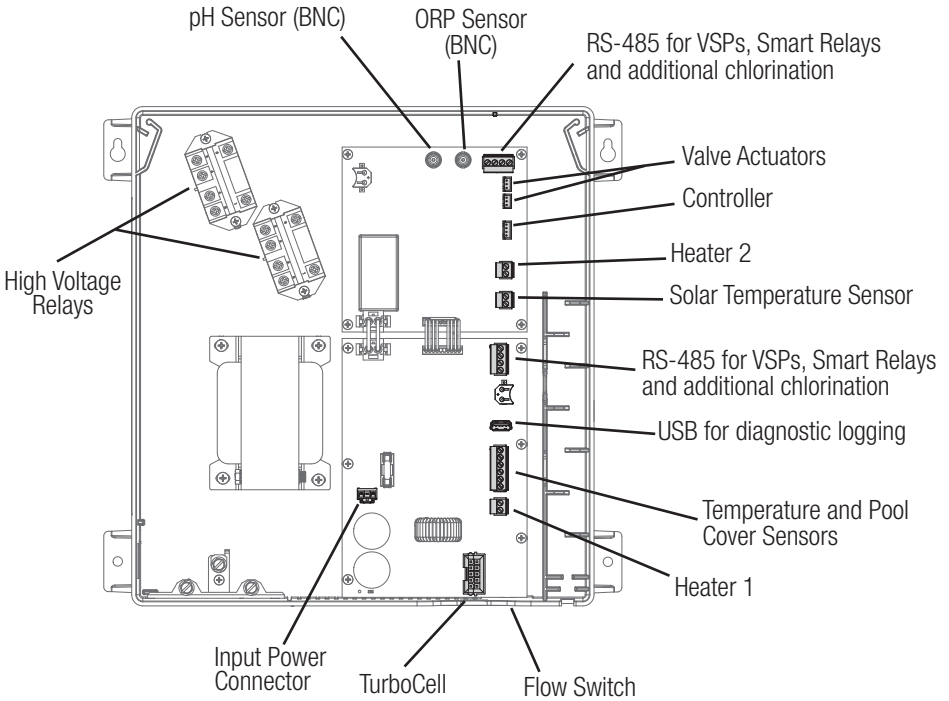



High Voltage Wiring

Single Speed Filter Pump and 120/240V Pool Equipment

The two internal relays in the AQR S3 Omni are dry contact double pole (make/break both “legs” of 240V circuits) and are rated at 3HP/30A at 240V (1½HP/30A at 120V) using wire with a minimum insulation rating of 75° C. Each relay can be used to power high voltage pool equipment like a single speed filter pump, light, accessory pump, transformer, etc. The diagram below shows typical relay wiring from a standard power panel.

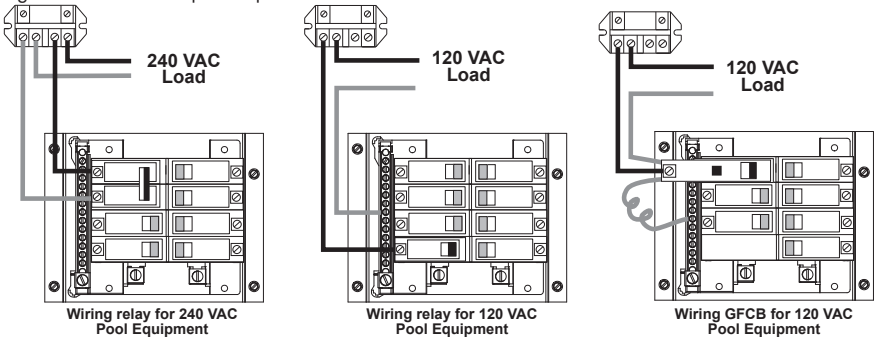

WARNING: Do not use the AQR S3 Omni to control an automatic pool cover. Swimmers may become entrapped underneath the cover.

WARNING: Do not use the AQR S3 Omni to control fire pits or fire features.

Two Speed Filter Pump

The AQR S3 Omni can control a two speed filter pump using both internal relays. Refer to the wiring diagram below. For proper wiring, observe the relay markings. Relays are labeled “1” and “2” and are shown on the diagram on page 14.

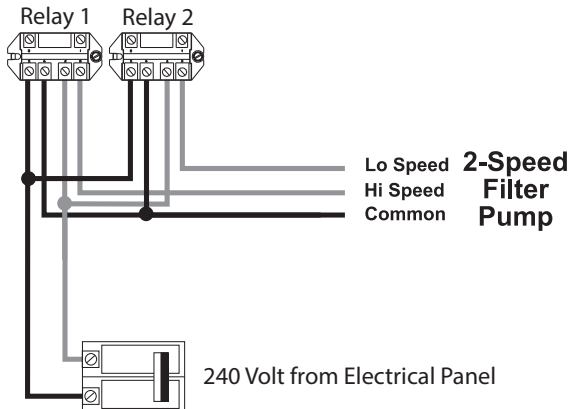



HAYWARD®

Smart Relay Load Wiring

In addition to the AQR S3 Omni's internal relays, an optional Smart Relay can be used to control either 115 or 230 VAC pool equipment. Smart Relays are sold separately and include an electrical box and Wiring Whip. If not using the included box, install the Smart Relay (HLH485RELAY) into an electrical box with a minimum volume of 16.2 in³. Use the included Wiring Whip if the electrical box will be mounted within 6 ft of the power source. Red, black and green conductors are included for 230 VAC wiring. A white conductor is supplied if using 115 VAC input power. Use the included wire nuts for wiring connections. Use proper threaded strain relief fittings when attaching conduit to knockouts. After wiring is complete, carefully insert the cover with connections into the box and secure.

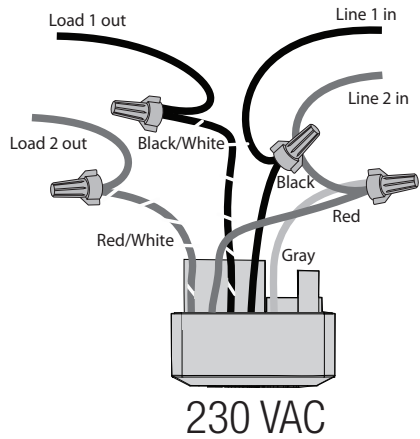
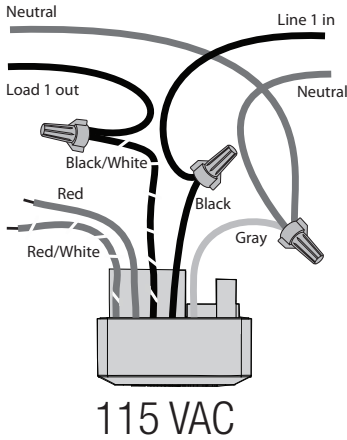

Low Voltage Wiring

Smart Relay Wiring

If connecting a Smart Relay, note that the relay relies on communication from the AQR S3 Omni. A Smart Relay comes with a 15ft (4.6m) 4 conductor cable and is wired to one of the two RS-485 connectors shown on page 9. To ease wiring, the connector can be lifted off the onboard pins. Connect the Smart Relay communication wires to their proper screw terminals, then push the connector back onto the pins. For best results, strip back leads 1/8" before inserting into the screw terminals.

Refer to the diagram on page 12. After connecting the wires to the connector, run the communication cable through the low voltage wiring channel as shown.



HAYWARD®

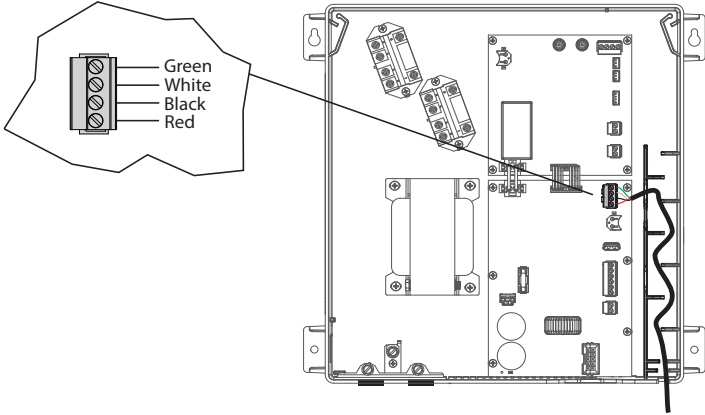

Home Router

If web enabled devices such as PCs, laptops, tablets or phones will be used to access the AQR S3 Omni, an Ethernet or wireless connection must be made to the home router. For wireless connections, a 2.4GHz connection to the router is required. For Ethernet connections, use outdoor rated Cat5e or Cat6 Ethernet cable. Connect one end to the Controller and the other to an available LAN port (not WAN) on the home router or access point.

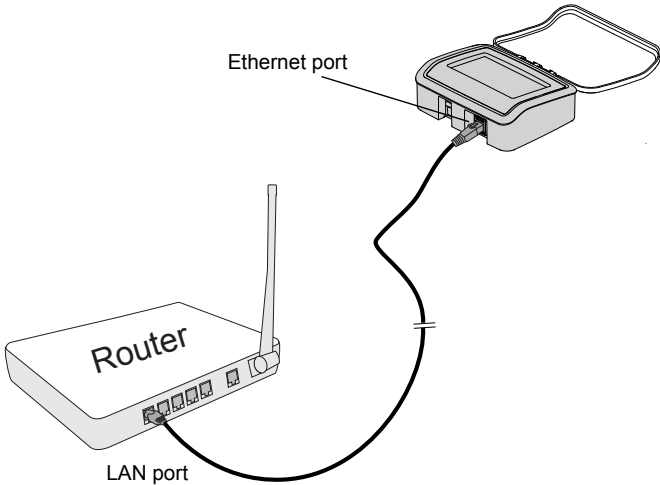



Valve Actuators

The AQR S3 Omni can control up to two automatic valve actuators. Two of the valve outputs are normally used for the pool/spa suction and return valves or for general purpose use (solar, water feature, in-floor cleaner, etc.).

For installations with solar heating, Hayward offers the AQ-SOL-KIT-xx solar kit that contains a valve, actuator, and extra temperature sensor. The “xx” indicates the valve type from the 2 choices below:

- 1P 1.5” Positive Seal
- 2P 2” Positive Seal

The AQR S3 Omni is compatible with standard valve actuators manufactured by Hayward, Pentair/Compool, and Jandy. Refer to the diagram on page 9 for the location of the AQR S3 Omni’s valve (VLV) connectors.

Connection Table and Final Steps

With all wiring completed, prepare the information that will be needed to configure the AQR S3 Omni. This includes identifying each connection and filling out the table below. Do not skip this step as this information will be required when starting the Configuration Wizard.

To fill out the adjacent table, refer to the diagram on page 14. The diagram shows the name of each connection (shown in the table’s “Connection” column). Fill in the type of pool equipment that is wired to each Connection. If no equipment is used, leave the selection blank. When completed, you’ll be ready to finish the installation.

Connection	Pool Equipment	Description
High Voltage Relays		
HVR1		
HVR2		
Smart Relay		
Low Voltage Relays/Heaters		
LVR1		
LVR2		
Valve Actuators		
VLV1		
VLV2		
Temperature Sensors		
SENS1 POOL		
SENS2 AIR		
SENS3 COVER		
SENS4 SOLAR		

Optional Smart Relay Purchased Separately



HAYWARD®

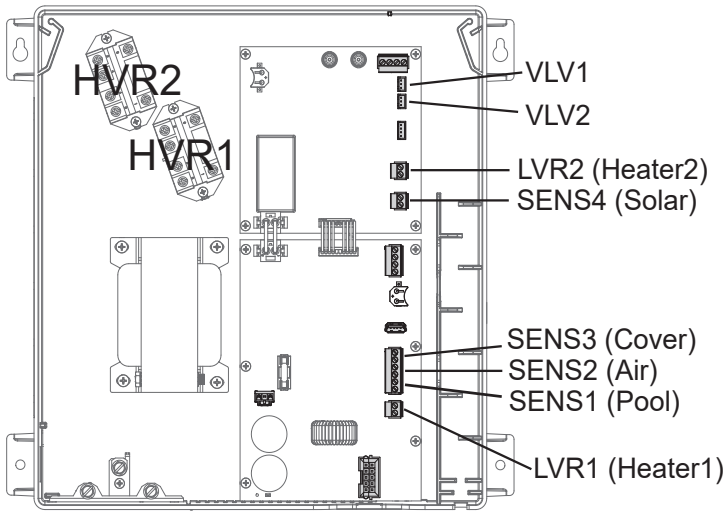

System Startup

Before Startup

You can now reinstall the deadfront and front display. Although the display will no longer be needed, it will show current status information that may be useful. Before starting the AQR S3 Omni for the first time, be sure that the following items have been completed:

1. Pool/spa chemicals are within the APSP recommended levels.
2. If using chlorinator function, pool/spa salt level is between 2700 – 3400 PPM for Standard Salt mode or 1200-1800 PPM for Low Salt mode.
3. All wiring is performed according to NEC and local codes.
4. The AQR S3 Omni is properly grounded.
5. The foam gasket and deadfront panel has been reinstalled.

Firmware Upgrade

The AQR S3 Omni's firmware is the basic operating system that runs the unit. The AQR S3 Omni was shipped with the version of firmware that was available at the time of release. There may be a newer version available and if so, we encourage you to upgrade. Also, if you have experienced problems, Hayward Technical Support may advise you to upgrade your AQR S3 Omni firmware. To upgrade the AQR S3 Omni firmware, refer to the procedure shown in the AQR S3 Omni Operation Manual. Upgrading firmware can be performed before or after Configuration but should be done before the AQR S3 Omni begins daily operation.



Configuration

Initial Configuration

The AQR S3 Omni can now be powered on for the first time. Apply power at the main panel and wait for the AQR S3 Omni to completely start. This may take a full minute or two. Because this is the first time that the AQR S3 Omni has been powered on, it will bring you directly to the initial configuration screen shown below. Note that the AQR S3 Omni uses a resistive touchscreen that is appropriate for a pool environment. It requires a deliberate push when selecting a button. At the initial configuration screen, touch the Configuration button in the center of the screen. On the following screen, touch the Configuration Wizard button as shown below.

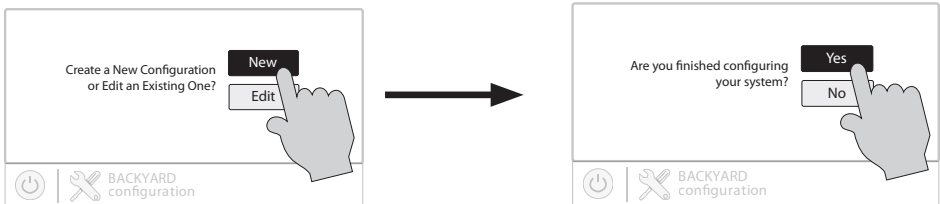

At the end of the Wizard, save your configuration by answering “Yes” to this screen.







About the Configuration Wizard

The AQR S3 Omni uses a Configuration Wizard to assist in the configuration of the AQR S3 Omni. The Configuration Wizard will ask you general questions relating to your pool/spa and specific questions about connected pool equipment. Because this process may take some time, do not begin to configure the AQR S3 Omni unless you can dedicate at least 15 minutes or more. Configuring the AQR S3 Omni requires knowledge of all of the connected pool equipment so have the Connection Table (page 13) handy while configuring the AQR S3 Omni.

If you are asked a question and don't know the answer, in many cases you'll be able to skip the question and proceed. In some cases the Configuration Wizard will require an answer. Answer the question to the best of your ability and take note as you'll be able to go back into the Configuration Wizard at a later time to make changes.

Navigation

The Configuration Wizard has been designed to be intuitive allowing most users the ability to navigate with little instruction. Some commonly used buttons are shown on the following page.

-  **Done** - Touch this button to complete your selection.
-  **Cancel** - Touch this button to cancel your selection.
-  **Advance** - Touch this button to advance to the next screen.
-  **Back** - Touch this button to return to the previous screen.
-  **Add** - Touch this button to add an item
-  **Delete** - Touch this button to delete a highlighted item.



After being prompted to make a selection or answer a question, touch the Done button (if available) and then the Advance button to go to the next screen. To go back to a previous screen, touch the Back button. Many selections will require you to touch the Done button before allowing you to advance. If a wrong selection has been made, touch the Delete button or Cancel. Some settings can be made by sliding a bar left or right to decrease or increase a value. You may be required to assign names to equipment. In this case, a keyboard will be displayed and you'll be able to type the desired name. After naming the equipment, save then advance. This method is repeated throughout the Configuration Wizard.

Begin the Configuration Wizard

In the Configuration Wizard, select "New" to create a new Configuration file for the AQR S3 Omni. Once underway, keep advancing until you have completed the Wizard. At the end of the Wizard, you'll have the opportunity to save your settings or exit without saving.

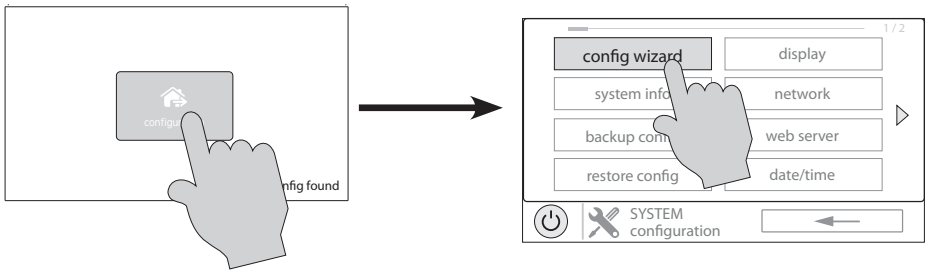

If additional pool or backyard equipment is added after initial configuration, or you'd like to make a change to an existing configuration setting, re-enter the Configuration Wizard and select "Edit". The initial configuration settings will be retained and you'll have an opportunity to make changes or additions. Be sure to save your configuration when exiting. See page 35 for a Quick Edit Guide.

Configuration Wizard Guide

As you progress through the Configuration Wizard, refer to the following information to help answer questions and make selections.

Would you like to set up a network connection now? Select the type of connection you would like to setup/modify or select "Not Now". For external antenna connections, you must have a Hayward HLWLAN connected to the AQR S3 Omni. "Wired" requires an ethernet connection to the router.

Wireless - From the Network Connections screen that follows, select the desired access point. You will then be prompted to input the password for that access point. Note that a 2.4GHz connection to the router is required. Once you input the password and press the check mark to continue, a Network Diagnostic screen will appear and the AQR S3 Omni will run through a series of checks to verify connection to the access point. When the system is done running through the diagnostics, press the check mark to continue to the next section of the Configuration Wizard.

Wired - For a wired connection, run an Ethernet cable from the Controller to the router (page 12). After selecting "Wired", the system will display the ip address and other network properties. Press the check mark and the AQR S3 Omni will verify the network connection. You can now exit back to the main menu and continue with the Configuration Wizard.



HAYWARD®

External Antenna - Make this selection when setting up a Hayward HLWLAN. Note that a 2.4GHz connection to the router is required. Once the system is done running through the diagnostics, press the check mark to continue to the next section of the Configuration Wizard.

Not Now - Skip network setup and continue with Configuration Wizard.

Enable Screen Color Changes For System Alerts? - To alert the user of warning conditions (no flow, failed sensor, etc.), the AQR S3 Omni can change its screen color. The screen can display yellow or red depending on the severity of the condition.

Time and Date - “Automatically get time and date from internet” and “Automatically adjust for daylight savings time” are enabled by default. It is recommended that you leave them enabled if your AQR S3 Omni system has an internet connection. Disabling “Automatically get time and date from internet” will allow you to set the current date and time using a 12hr clock (AM/PM) or 24hr clock (military time). Save by touching the Done button when finished. NOTE: When registering the AQR S3 Omni and creating a web account, you’ll be prompted to enter a Time Zone. Be sure to enter the same time zone as the physical location of the AQR S3 Omni, otherwise schedules and timers will be inaccurate.

Select Desired Units of Measure - If Standard is selected, temperatures will be displayed in Fahrenheit. If Metric is selected, temperatures will be displayed in Celsius.

MSP ID - The AQR S3 Omni MSP ID number will be displayed. This unique number is used to identify your AQR S3 Omni when setting up a web account. A web account is needed to access the AQR S3 Omni over the web by mobile devices. **IMPORTANT:** write down the MSP ID number for future use. The MSP ID number will be needed when entering the configuration wizard after initial configuration as well as entering and exiting Simple Mode. Simple Mode is a customizable screen that can be set up for quick access to pool/spa functions and features.

How many Bodies of Water? The AQR S3 Omni can support one or two bodies of water, typically a pool and spa. Select the number and advance. You’ll be brought to a screen where you can add, delete or edit a Body of Water. When initially configuring the AQR S3 Omni, a “?” will appear in the Body of Water button. You will have to configure this body of water by selecting it and then touching the Advance button. When finished configuring bodies of water, you’ll be returned to this same screen. Touch the Done button and advance to the next section of configuration.

IMPORTANT: The following instructions are for Body of Water 1 configuration. When finished with the first Body of Water, you’ll follow the same instructions for the second Body of Water. When configuring the second Body of Water, you’ll have the option of using “Shared Equipment”. If Shared Equipment is enabled, the second Body of Water will use the filter pump as well as other equipment (heater, chlorinator, etc.) that has been assigned to the first Body of Water. Additionally, you will have the option for using “Shared Heaters”. If you have dual equipment with shared heaters, this can be configured from the second Body of Water’s configuration menu. See page 31 for more information regarding Shared Equipment in the second Body of Water configuration menu.

What is the Body of Water type? Select the type of Body of Water that you would like to configure. The choices are Pool and Spa.

Name of Body of Water - Selecting the box will allow you to edit the name. During initial con-



HAYWARD®

figuration, the box will be blank. Select the box and then use the keyboard to enter the desired name of the body of water.

Size of Body of Water - Enter the Body of Water size in gallons.

How Many Filter Pumps? - This question is for THIS BODY OF WATER ONLY. For example: If you have 2 pumps; one for the pool Body of Water and one for the spa Body of Water, you would answer "1" to this question.

If "1" or more is selected:

Name Filter Pump - Touch the box and use the keyboard to name the filter pump.

What Type - Depending on your answer, the AQR S3 Omni will use one relay (single speed pumps), two relays (two speed pumps) or the low speed communication bus (VSP pumps) for pump control. Select the type of pump and advance.

If one speed or two speed pump is selected:

Which Relay is it Wired to? If using a single speed or two speed pump, you'll be asked which relay(s) is wired to the pump. If a value is already shown in the box(es), advance to the next screen. If no value is shown, selecting the box will bring you to a table showing all detected relays. Select the proper relay(s) from the table and touch the Done button to proceed. The relay(s) should now be shown in the box(es) and you can advance to the next screen to continue the pump configuration.

Filter Pump Off for Valve Change? When Yes is selected, the pump will shut off for 35 seconds whenever the valve(s) change position.

Flow Monitoring Enabled? This feature will help protect the filter pump from damage due to no flow. When Yes is selected, the AQR S3 Omni will monitor the state of water flow when the filter pump is on. If no flow is detected for more than 15 minutes, the AQR S3 Omni will shut down the pool pump and will indicate an error. The error will be cleared the next time the pump is turned on.

Would You Like to Enable Priming? Select whether you want the filter pump to prime when turned on. This will turn the pump on at high speed for a set amount of time to establish normal water flow every time the pump is activated after being off for at least 30 seconds. If **Yes** is selected, the following screen will allow you to choose the length of time the pump will prime. This option only appears if the filter pump is configured as a 2-Speed pump.

Freeze Protection Enabled? Freeze protection is used to protect the pool and plumbed equipment against freeze damage during cold temperatures. If freeze protection is enabled AND the air temperature falls below the freeze threshold, the AQR S3 Omni will turn on the filter pump to circulate the water. If two Bodies of Water are configured, the valves will also alternate between the pool and spa every 30 minutes and the filter pump will turn off while the valves are turning. The chlorinator will not operate if freeze protection is the only reason the pump is running.



HAYWARD®

If Yes is selected:

Freeze Protection Temperature? Select the temperature to be used for freeze protection. Temperature is adjustable from 33°F-42°F (1°C-6°C). 38°F (3°C) is default. This threshold will be used for all outputs that have freeze protection enabled.

If VSP is selected:

Which Hayward Unique Address? If using a VSP, you'll be asked what is the Hayward Unique Address (HUA). If a value is already shown in the box, advance to the next screen. If no value is shown, selecting the box will bring you to a table showing all detected devices. Select the proper HUA from the table and touch the Done button. If unsure of the HUA, refer to the pump's manual for instructions on how to determine the pump's HUA. Once selected, the address should now be shown in the box and you can advance to the next screen to continue the VSP configuration.

Pump Capacity - Set the minimum and maximum RPM of the pump. Refer to your pump manual for more information.

Permitted User Setting - The AQR S3 Omni will automatically calculate these values based on the minimum and maximum RPM that were previously entered. They can be changed as desired.

Speed Presets - Set the Low Pump Speed %, Medium Pump Speed %, and High Pump Speed %, presets. These presets will be used when setting schedules for your pump.

Filter Pump Off for Valve Change? When Yes is selected, the pump will shut off for 35 seconds whenever the valve(s) change position.

Flow Monitoring Enabled? Requires use of a Hayward flow switch. This feature will help protect the filter pump from damage due to no flow. When Yes is selected, the AQR S3 Omni will monitor the state of water flow when the filter pump is on. If no flow is detected for more than 15 minutes, the AQR S3 Omni will shut down the pool pump and will indicate an error. The error will be cleared the next time the pump is turned on.

Would You Like to Enable Priming? Select whether you want the filter pump to prime when turned on. This will turn the pump on at high speed for a set amount of time to establish normal water flow every time the pump is activated after being off for at least 30 seconds. If **Yes** is selected, the following screen will allow you to choose the length of time the pump will prime.

Freeze Protection Enabled? Freeze protection is used to protect the pool and plumbed equipment against freeze damage during cold temperatures. If freeze protection is enabled AND the air temperature falls below the freeze threshold, the AQR S3 Omni will turn on the filter pump to circulate the water. If two Bodies of Water are configured, the valves will also



HAYWARD®

alternate between the pool and spa every 30 minutes and the filter pump will turn off while the valves are turning. The chlorinator will not operate if freeze protection is the only reason the pump is running.

If Yes is selected:

Freeze Protect Temperature? Select the temperature to be used for freeze protection. Temperature is adjustable from 33°F-42°F (1°C-6°C). 38°F (3°C) is default. This threshold will be used for all outputs that have freeze protection enabled.

Freeze Protect Speed? This is the speed of the pump while freeze protection is active. Select the desired pump speed %.

How Many Heaters? - This question is for THIS BODY OF WATER ONLY. For example: If you have 2 heaters, one for the pool Body of Water and one for the spa Body of Water, you would answer "1" to this question. Note that you can have a maximum of 3 heaters/chillers per Body of Water.

If "1" or more is selected:

Heater Cooldown Enabled? This feature ensures that the heater cools down before water circulation is stopped. When enabled, the AQR S3 Omni will continue to run the filter pump for 5 minutes after the heater turns off.

Heater Extend Enabled? If "Enabled", the filter extend logic keeps the filter pump running beyond the normal turn-off time until the pool (or spa) is heated up to the desired temperature setting. Heater extend will NOT cause the filter pump to turn on, it will only delay the turn off time when the heater is operating.

Settable Water Temperature Range? This is the maximum and minimum allowed settings for heating and/or cooling.

Select and Configure a Heater At this screen, you can add, delete and configure your heater(s). Select the desired heater, then touch the Advance button. When finished configuring heater(s), you'll be returned to this same screen. Touch the Done button and advance to the next section of configuration. Refer to the following information when configuring heater(s):

Do you want to configure a Smart Heater? This option only appears if you have a heater with Omni remote control capability connected to your AQR S3 Omni and powered on. Select "Yes" if you would like to configure this heater now or "No" if you would like to configure a different heater.

If Yes is selected:

Which Hayward Unique Address? Select the HUA of the Smart Heater that you would like to configure.

Name Heater Select the box, then type the desired name for your heater. This name will be used when referring to this particular heater.

Does Heater Have a Valve? Select whether or not the heater has an associated valve that will turn on when the heater is activated. If **Yes** is selected, the following screen will ask where the valve is wired.



HAYWARD®

Minimum Allowed Air Temperature for Heater? If the air temperature falls below this setting, the heater will be prevented from running, regardless of conditions. This feature is especially useful for heat pumps which become less efficient as the outdoor ambient temperature falls.

Minimum Operation Speed? For variable speed pumps, select the lowest pump speed that is allowed while heating. Set a speed that will ensure that there will be sufficient flow for the heater to operate properly. For two speed pumps, you can select if you want to allow the filter pump to run at low speed during heater operation.

What Type? Heater choices are Solar, Heat Pump, Gas, Geothermal, and Electric. Make your selection and advance.

If Gas or Electric Heater is selected:

Name Heater: Select the box, then type the desired name for your heater. This name will be used when referring to this particular heater.

Which Relay is it Wired to? Selecting the box will bring you to a table showing all detected relays. Select the low voltage relay that is wired to the heater (refer to the Connection Table for this information), then advance. The relay should now be shown in the box. Advance to the next screen to continue gas heater configuration.

Does Heater Have a Valve? Select whether or not the heater has an associated valve that will turn on when the heater is activated. If **Yes** is selected, the following screen will ask where the valve is wired.

Heater Priority Duration? This question will appear if more than one heater is configured. Set the amount of time that you will allow the priority heater to heat before allowing the next heater to start. If the priority heater meets the demand within this time frame, the next heater will not be used. Note that a time interval setting of "0" will eliminate priority and always run both heaters at the same time. If a time interval setting of "24" is selected, the next priority heater will not turn on until the first priority heater becomes invalid to run.

Minimum Operation Speed? For variable speed pumps, select the lowest pump speed that is allowed while heating. Set a speed that will ensure that there will be sufficient flow for the heater to operate properly. For two speed pumps, you can select if you want to allow the filter pump to run at low speed during heater operation.

If Heat Pump or Geothermal is selected:

Name Heater: Select the box, then type the desired name for your heater. This name will be used when referring to this particular heater.

Which Relay is it Wired to? Selecting the box will bring you to a table showing all detected relays. Select the low voltage relay that is wired to the heater (refer to the Connection Table for this information), then advance. The relay should now be shown in the box. Advance to the next screen to



HAYWARD®

continue heat pump configuration.

Does Heater Have a Valve? Select whether or not the heater has an associated valve that will turn on when the heater is activated. If **Yes** is selected, the following screen will ask where the valve is wired.

Does Heater Support Cooling? If your Heat Pump or Geothermal Heater supports cooling and you would like to use it to chill your pool/spa water, select **Yes** to this question. If **Yes** is selected, the following screen will ask where the cooling relay is located.

Heater Priority Duration? This question will appear if more than one heater is configured. Set the amount of time that you will allow the priority heater to heat before allowing the next heater to start. If the priority heater meets the demand within this time frame, the next heater will not be used. Note that a time interval setting of "0" will eliminate priority and always run both heaters at the same time. If a time interval setting of "24" is selected, the next priority heater will not turn on until the first priority heater becomes invalid to run.

Minimum Allowed Air Temperature for Heater? (Heat Pump Only) If the air temperature falls below this setting, the heater will be prevented from running, regardless of conditions. This feature is especially useful for heat pumps which become less efficient as the outdoor ambient temperature falls.

Minimum Operation Speed? For variable speed pumps, select the lowest pump speed that is allowed while heating. Set a speed that will ensure that there will be sufficient flow for the heater to operate properly. For two speed pumps, you can select if you want to allow the filter pump to run at low speed during heater operation.

If Solar is selected:

Name Heater Select the box, then type the desired name for your heater. This name will be used when referring to this particular heater.

Does the Solar Heater Have a Pump? Select whether the solar heating system has a dedicated recirculation pump. If so, the OmniPL will turn this pump on when the pool temperature is below the heater setting and there is solar heat available.

If Yes is selected:

Which Relay is it Wired to? Selecting the box will bring you to a table showing all detected relays. Select the high voltage relay that is wired to the heater (refer to the Connection Table in for this information), then advance. The relay should now be shown in the box. Advance to the next screen to continue solar heater configuration.

Does the Solar Heater Have a Valve? Select whether the solar heating system has a diverter valve to route pool/spa water through the solar collectors. If so, the OmniPL will rotate this valve when the pool temperature is below the heater setting and there is solar heat available.



HAYWARD®

If Yes is selected:

Where is the valve wired? Selecting the box will bring you to a table showing all detected low voltage relays. Select the relay that is wired to the solar valve, then advance. The relay should now be shown in the box. Advance to the next screen to continue solar heater configuration.

Where is the Solar Temperature Sensor Located? Selecting the box will bring you to a table showing all detected sensors. Select the solar sensor (usually SENS3), then advance. The sensor should now be shown in the box. Advance to the next screen to continue solar heater configuration.

Heater Priority Duration? This question will appear if more than one heater is configured. Set the amount of time that you will allow the priority heater ("1") to heat before allowing the next heater to start. If the priority heater meets the demand within this time frame, the next heater will not be used. Note that a time interval setting of "0" will eliminate priority and always run both heaters at the same time. If a time interval setting of "24" is selected, the next priority heater will not turn on until the first priority heater becomes invalid to run.

Does Solar Require the Filter Pump to Prime When it First Turns On? If *Yes* is selected, the filter pump will turn on in high speed for 3 minutes to circulate water to the solar panels when the heater is activated. This setting is especially useful if you do not have a boost pump to push the pool/spa water to the roof.

Minimum Operation Speed? Select the lowest pump speed that is allowed while solar heating. Set a speed that will ensure that there will be sufficient flow for the solar heating system to operate properly. For two speed pumps, you can select if you want to allow the filter pump to run at low speed during heater operation.

Would You Like To Prioritize The Use Of Solar Heating Over Any Other Types? Select *Yes* if you would like your solar heater to always be the number 1 heater priority if multiple heaters are configured.

How Many Chillers? This question is for THIS BODY OF WATER ONLY. For example: If you have 2 chillers, one for the pool and one for the spa, you would answer "1" to this question. Note that you can have a maximum of 3 heaters/chillers per Body of Water.

If "1" or more is selected:

Name Chiller Select the box, then type the desired name for your chiller. This name will be used when referring to this particular chiller.

Is Chiller Wired to a Relay? Select whether or not the Chiller is wired to a relay. If *Yes* is selected, the following screen will ask you to select where the relay is wired.

Does Chiller Have a Valve? Select whether or not the Chiller has an associated valve. If *Yes* is selected, the following screen will ask you to select where the valve is wired.



HAYWARD®

Chiller Priority Duration? This question will appear if more than one chiller is configured. Set the amount of time that you will allow the priority chiller to cool before allowing the next chiller to start. If the priority chiller meets the demand within this time frame, the next chiller will not be used. Note that a time interval setting of "0" will eliminate priority and always run both chillers at the same time. If a time interval setting of "24" is selected, the next priority chiller will not turn on until the first priority chiller becomes invalid to run.

Minimum Operation Speed? Select the lowest pump speed that is allowed while solar heating. Set a speed that will ensure that there will be sufficient flow for the solar heating system to operate properly. For two speed pumps, you can select if you want to allow the filter pump to run at low speed during heater operation.

Do you have a Sense & Dispense Module? Select Yes if a Hayward HL-CHEM (sold separately) is connected to the AQR S3 Omni.

If Yes is selected:

The next few screens will configure the AQR S3 Omni to use Sense and Dispense. The AQR S3 Omni automatically detects smart components like the HL-CHEM, and assigns a Hayward Unique Address. If multiple components are detected, the AQR S3 Omni will show a table of devices and prompt you to select the proper device.

Which Hayward Unique Address? If a Hayward Unique Address (HUA) is already shown in the box, touch the Advance button. If no address is shown, selecting the box will bring you to a table showing all detected Sense and Dispense devices. Select the HL-CHEM from the table and touch the Done button to advance. The address should now be shown. Touch the Advance button to continue configuring the AQR S3 Omni for use with the HL-CHEM.

Does ORP Control Chlorination? If you say Yes to this, the HL-CHEM will constantly measure ORP and will adjust the pool's chlorine based on a predetermined setpoint that you will select. The system will monitor ORP and automatically generate/dispense the correct amount of chlorine to maintain a desired level. Alternatively, if you say No to this question and select a TurboCell, the HL-CHEM will monitor ORP, but the amount of chlorine generated will be based on a manual setting that you will select.

If Yes is selected:

ORP Setpoint - Set the desired ORP level which is measured in mV. 650mV is the default. The AQR S3 Omni will continuously measure ORP and generate/dispense the proper amount of chlorine to maintain this setpoint.

ORP Timeout - Select a timeout interval. If the AQR S3 Omni has been chlorinating for more than the selected ORP timeout without reaching the desired level, the chlorinator will turn off and display an alarm. The user must clear the alarm to resume chlorination.

Type of Chlorinator? Select the Hayward TurboCell model, liquid chlorinator or tablet feeder that is installed in your system. A flow switch must be installed when using a chlorinator.

If TurboCell model is selected (requires a connected Hayward TurboCell or AquaRite with HLAQRPCB communication board):



HAYWARD®

Select Salt Monitoring Level - Select Standard Salt or Low Salt. If running the system using a low salt level (1200 PPM-1800 PPM, 1500 PPM optimal) select Low Salt. If running the system using standard salt level (2700 PPM - 3400 PPM, 3200 PPM optimal), select Standard Salt.

Where is the Cell Located? If an entry is already shown in the box, touch the Advance button. If no entry is shown, selecting the box will bring you to a table showing the detected cells. The AQR S3 Omni will detect a directly connected TurboCell and/or a TurboCell that is connected to an AquaRite (requires HLAQRPCB communication board). The table will display "Main Panel" under device type for directly connected TurboCells and "AquaRite", if a AquaRite is used.

If Liquid Chlorinator is selected:

Select Relay - Selecting the box will bring you to a table showing all HV relays. Find the relay that is connected to the Liquid Chlorinator. Select the relay and select Done.

If Tablet Feeder is selected:

Where is the Valve Wired? - Selecting the box will bring you to a table showing all valve outputs. Find the valve that is connected to the Tablet Feeder. Select the valve and select Done.

If No is selected:

Do You Have a Salt Water Chlorine Generator? (requires a connected Hayward TurboCell or AquaRite with HLAQRPCB communication board)

If Yes is selected:

Type of Cell? Select the type of Hayward TurboCell that is installed in your system.

Where is the Cell Located? If an entry is already shown in the box, touch the Advance button. If no entry is shown, selecting the box will bring you to a table showing the detected cells. The AQR S3 Omni will detect a directly connected TurboCell and/or a TurboCell that is connected to an AquaRite (requires HLAQRPCB communication board). The table will display "Main Panel" under device type for directly connected TurboCells and "AquaRite", if an AquaRite is used.

Percentage of Output? The AQR S3 Omni can only generate chlorine while the filter pump is operating. Set the percentage of run time that you desire chlorine generation. Raise this value to generate more chlorine. Lower this value to generate less.

Is pH Reduction Enabled? Select Yes if you have a dispenser to lower pH connected to the AQR S3 Omni.

If Yes is selected:

Are you Using Acid or CO2? Select one.



HAYWARD®

How Many Acid/CO₂ Dispensers? Select the number of Acid/CO₂ dispensers in your system.

Which relay is it Wired to? Select the box to advance to the High Voltage Table. This table lists all of the high voltage relays that are installed in the AQR S3 Omni. Select the relay that is wired to the pH dispense unit. Refer to the Connection Table for this information.

pH Setpoint - Selecting the box will allow you to change the setpoint (7.5 default). Touch the Advance button when finished.

pH Dispensing Timeout - Select a timeout interval. If the unit has been dispensing for more than the selected timeout without reaching the desired level, pH dispensing will turn off and an alarm will be displayed. Check the chemical supply and the feeder. If both are OK, the timeout may need to be increased. The user must clear the alarm to resume pH dispensing.

pH Extend Enabled - If enabled, the AQR S3 Omni will continue to run the filter pump regardless of schedule until the pH level in the pool has reached the setpoint.

How Many Cleaners? - This question is for THIS BODY OF WATER ONLY. For example: If you have 2 cleaners; one for the pool Body of Water and one for the spa Body of Water, you would answer "1" to this question.

If "1" or more is selected:

Select and Configure a Cleaner At this screen you can add, delete and configure your cleaner(s). Select the desired cleaner, then touch the Advance button. When finished configuring cleaner(s), you'll be returned to this same screen. Touch the Done button to advance to the next section of configuration. Refer to the following information when configuring cleaner(s):

Type of Cleaner? Touch the box and select the type of cleaner used. Choices are Pressure, Suction, Robotic and In-Floor.

Name of Cleaner - Touch the box and use the keyboard to name the cleaner.

Does Cleaner Have a Pump? Select whether the cleaner has a dedicated pump. If so, the AQR S3 Omni will turn this pump on when the cleaner is scheduled to run.

If Yes is selected:

What Type? Select the type of pump used. The choices are Single Speed, Two Speed and VSP.

If single speed or two speed pump is selected:

Which Relay is it Wired to? If using a single speed or two speed pump, you'll be asked which relay(s) is wired to the pump. If a value is already shown in the box(es), advance to the next screen. If no value is shown, selecting the box will bring you to a table showing all detected relays. Select the proper relay(s) from the table and touch the Done button. The relay should now be shown in the box(es) and you



HAYWARD®

can advance to the next screen to continue the pump configuration.

Would You Like to Enable Priming? Select whether you want the pump to prime when turned on. This will turn the pump on at high speed for a set duration to establish normal water flow every time the pump is activated after being off for at least 30 seconds. This option only appears if the pump is configured as a 2-speed pump.

If VSP is selected:

Which Hayward Unique Address? If using a VSP for your cleaner pump, you'll be asked what is the Hayward Unique Address (HUA). If a value is already shown in the box, advance to the next screen. If no value is shown, selecting the box will bring you to a table showing all detected devices. Select the proper HUA from the table and touch the Done button. The address should now be shown in the box and you can advance to the next screen to continue the VSP configuration.

Pump Capacity - Set the minimum and maximum RPM of the pump. Refer to your pump manual for more information.

Permitted User Setting - The AQR S3 Omni will automatically calculate these values based on the minimum and maximum RPM that were previously entered. They can be changed as desired.

Speed Presets - Set the Low Pump Speed %, Medium Pump Speed %, and High Pump Speed %, presets. These presets will be used when setting schedules for your pump.

Would You Like to Enable Priming? Select whether you want the pump to prime when turned on. This will turn the pump on at high speed for 3 minutes to establish normal water flow every time the pump is activated after being off for at least 30 seconds.

Does Cleaner have a Valve? Select whether the cleaner requires a valve to change position when in use.

If Yes is selected:

How Many? Select how many valves are used for the cleaner.

Where is the Valve(s) Wired? Selecting the box will bring you to a table showing all detected low voltage relays. Select the relay(s) that is wired to the cleaner valve(s), then advance. The valve(s) should now be shown in the box(es). Advance to the next screen to continue cleaner configuration.

Would you like your valve(s) to cycle On and Off at a set interval? If you would like the cleaner valve(s) to cycle to a set interval while cleaning, select Yes. Set the interval on the next screen.

Freeze Protection Enabled? Freeze protection is used to protect the pool and plumbed equipment against freeze damage during cold temperatures. If freeze pro-



HAYWARD®

tection is enabled AND the air temperature falls below the freeze threshold (refer to pump configuration), the AQR S3 Omni will turn on the cleaner pump to circulate the water.

How Many Water Features? - This question is for THIS BODY OF WATER ONLY. For example: If you have 2 water features; one for the pool Body of Water and one for the spa Body of Water, you would answer "1" to this question.

If "1" or more is selected:

Select and Configure a Water Feature At this screen you can add, delete and configure your water features. Select the desired water feature, then touch the Advance button. When finished configuring water features, you'll be returned to this same screen. Touch the Done button and advance to the next section of configuration. Refer to the following information when configuring water features:

Type of Water Feature? Touch the box and select the type of water feature used. Choices are Water Feature, Water Slide, Waterfall, and Fountain.

Name of Water Feature - Touch the box and use the keyboard to name the water feature.

Does Water feature Have a Pump? Select whether the water feature has a dedicated pump. If so, the AQR S3 Omni will turn this pump on when the water feature is scheduled to run.

If Yes is selected:

What Type? Select the type of pump used. The choices are Single Speed, Two Speed and VSP.

If single speed or two speed pump is selected:

Which Relay is it Wired to? If using a single speed or two speed pump, you'll be asked which relay(s) is wired to the pump. If a value is already shown in the box(es), advance to the next screen. If no value is shown, selecting the box will bring you to a table showing all detected relays. Select the proper relay(s) from the table and touch the Done. The relay(s) should now be shown in the box(es) and you can advance to the next screen to continue the pump configuration.

Would You Like to Enable Priming? Select whether you want the pump to prime when turned on. This will turn the pump on at high speed for a set duration to establish normal water flow every time the pump is activated after being off for at least 30 seconds. This option only appears if the pump is configured as a 2-speed pump.

If VSP is selected:

Which Hayward Unique Address? If using a VSP for your water feature pump, you'll be asked what is the Hayward Unique Address (HUA). If a value is already shown in the box, advance to the next screen. If no value is shown, selecting the box will bring you to a table showing all detected devices. Select the proper HUA from the table and touch the Done button. If unsure of the HUA, refer to the pump's manual for instructions on how to determine the pump's HUA. Once



HAYWARD®

selected, the address should now be shown in the box and you can advance to the next screen to continue the VSP configuration.

Pump Capacity - Set the minimum and maximum RPM of the pump. Refer to your pump manual for more information.

Permitted User Setting - The AQR S3 Omni will automatically calculate these values based on the minimum and maximum RPM that were previously entered. They can be changed as desired.

Speed Presets - Set the Low Pump Speed %, Medium Pump Speed %, and High Pump Speed %, presets. These presets will be used when setting schedules for your pump.

Would You Like to Enable Priming? Select whether you want the pump to prime when turned on. This will turn the pump on at high speed for 3 minutes to establish normal water flow every time the pump is activated after being off for at least 30 seconds.

Water Feature Wired to a Relay? Select whether the water feature requires the use of a high voltage relay.

If Yes is selected:

Select Relay - Touching the box will bring you to a table showing all detected relays. Select the relay(s) that is connected to the water feature and touch the Done button. The relay should now be shown in the box and you can advance to the next screen to continue water feature configuration.

Does Water Feature have a Valve? Select whether the water feature requires a valve to change position when in use.

If Yes is selected:

How Many? Select how many valves are used for the water feature.

Where is the Valve(s) Wired? Selecting the box will bring you to a table showing all detected low voltage relays. Select the relay(s) that is wired to the water feature valve(s), then advance. The valve(s) should now be shown in the box. Advance to the next screen to continue water feature configuration.

Freeze Protection Enabled? Freeze protection is used to protect the pool and plumbed equipment against freeze damage during cold temperatures. If freeze protection is enabled AND the air temperature falls below the freeze threshold (refer to pump configuration), the AQR S3 Omni will turn on the water feature pump to circulate the water.

Would You Like To Configure A Default Startup Speed For Water Feature? If the water feature has a valve and the system uses a VSP filter pump, the AQR S3 Omni allows you to set a startup pump speed for the water feature, regardless of the pump's schedule. The speed will change at the next scheduled interval.



HAYWARD®

Do You Want to Configure Any Lights? Select yes if you are using any type of pool or spa lights. The options are Universal ColorLogic (UCL), ColorLogic 4.0 (CL4.0), ColorLogic 2.5 (CL2.5), WaterBowl, Pentair Color LED (P-COLOR), Jandy Color LED (Z-Color), Incandescent, and Other. Transformers powering Universal ColorLogic lights must all be connected to the same high voltage relay for synchronization to function properly.

If Yes is selected:

What Kind of Lights? Touch the box to select the type of lights that will be used. The options are UCL (14V), CL4.0 (115V), CL2.5 (14V), WaterBowl, P-Color, Z-Color, Incandescent, and Other.

Name the Group of Lights - Touch the box and use the keyboard to name the lights.

How Many Relays are Lights Wired to? Select the number of relays used by the lights.

Which Relay is it Wired to? Touching the box(es) will bring you to a table showing all detected relays. Select the relay(s) that are connected to the lights and touch the Done button. If the lights are connected to a Smart Power Transformer, select the zone(s) that the lights are wired to. The relay(s) should now be shown in the box(es) and you can advance to the next screen to continue the configuration.

If UCL was previously selected:

Would you like to test for Omni Direct capability? For UCL lights manufactured after June 2018, you can select Yes and the AQR S3 Omni will test your lights to confirm. If your lights blink white after the test, you can enable Omni Direct mode. If not, the UCL light will default to UCL Standalone mode. Note that if you are configuring a WaterBowl light, the Flicker feature will only be available if the light is set to OmniDirect mode.

How Many Accessories? Select the number of accessories that will be used for this Body of Water only. You'll have an opportunity to configure accessories for the spa and also the backyard at a later point.

If "1" or more is selected:

Select and Configure Accessories At this screen you can add, delete and configure your accessories. Select the desired accessory, then touch the Advance button. When finished configuring accessories, you'll be returned to this same screen. Touch the Done button and advance to the next section of configuration. Refer to the following information when configuring accessories:

Type of Accessory? Touch the box and select the type of accessory used. Choices are Laminars, Jets, Blower and Other.

Name of Accessory - Touch the box and use the keyboard to name the accessory.

Does Accessory Have a Pump? Select whether the accessory has a dedicated pump. If so, the AQR S3 Omni will turn this pump on when the accessory is scheduled to run.

If Yes is selected:

What Type? Select the type of pump used. The choices are Single Speed, Two Speed and VSP.



HAYWARD®

If single speed or two speed pump is selected:

Which Relay is it Wired to? If using a single speed or two speed pump, you'll be asked which relay(s) is wired to the pump. If a value is already shown in the box(es), advance to the next screen. If no value is shown, selecting the box will bring you to a table showing all detected relays. Select the proper relay(s) from the table and touch the Done button. The relay(s) should now be shown in the box(es) and you can advance to the next screen to continue the pump configuration.

Would You Like to Enable Priming? Select whether you want the pump to prime when turned on. This will turn the pump on at high speed for a set duration to establish normal water flow every time the pump is activated after being off for at least 30 seconds. This option only appears if the pump is configured as a 2-Speed pump.

If VSP is selected:

Which Hayward Unique Address? If using a VSP for your accessory pump, you'll be asked what is the Hayward Unique Address (HUA). If a value is already shown in the box, advance to the next screen. If no value is shown, selecting the box will bring you to a table showing all detected devices. Select the proper HUA from the table and touch the Done button. The address should now be shown in the box and you can advance to the next screen to continue the VSP configuration.

Pump Capacity - Set the minimum and maximum RPM of the pump. Refer to your pump manual for more information.

Permitted User Setting - The AQR S3 Omni will automatically calculate these values based on the minimum and maximum RPM that were previously entered. They can be changed as desired.

Speed Presets - Set the Low Pump Speed %, Medium Pump Speed %, and High Pump Speed %, presets. These presets will be used when setting schedules for your pump.

Would You Like to Enable Priming? Select whether you want the pump to prime when turned on. This will turn the pump on at high speed for 3 minutes to establish normal water flow every time the pump is activated after being off for at least 30 seconds.

Accessory Wired to Relay? Select whether the accessory requires the use of a high voltage relay.

If Yes is selected:

Select Relay - Touching the box will bring you to a table showing all detected relays. Select the relay that is connected to the accessory and touch the Done button. The relay should now be shown in the box and you can advance to the next screen to continue the accessory configuration.



HAYWARD®

Does Accessory have a Valve? Select whether the accessory requires a valve to change position when in use.

If Yes is selected:

How Many? Select how many valves are used for the accessory.

Where is the Valve(s) Wired? Selecting the box will bring you to a table showing all detected low voltage relays. Select the relay(s) that is wired to the accessory valve(s), then advance. The valve(s) should now be shown in the box. Advance to the next screen to continue accessory configuration.

Freeze Protection Enabled? Freeze protection is used to protect the pool and plumbed equipment against freeze damage during cold temperatures. If freeze protection is enabled AND the air temperature falls below the freeze threshold (refer to pump configuration), the AQR S3 Omni will turn on the accessory pump to circulate the water.

Would You Like To Configure A Default Startup Speed For the Accessory? If the accessory has a valve and the system uses a VSP filter pump, the AQR S3 Omni allows you to set a startup pump speed for the accessory, regardless of the pump's schedule. The speed will change at the next scheduled interval.

NOTE: The following configuration settings are specific to the second Body of Water regarding Shared Equipment and Dual Equipment with shared heaters setup.

As you advance through the second Body of Water's configuration settings, note that most of the questions asked are the same as the first Body of Water with the exception of the following:

Does Body of Water 2 share its equipment with Body of Water 1?

If Yes is selected:

Your system will be "fully shared" which means your filter pump/heaters/chemistry will be shared between both Bodies of Water. You can now set your filter pump and heater settings for this body of water.

If No is selected:

You will begin dual equipment setup for you second Body of Water. This means that your filter pump and chemistry will not be shared between both Bodies of Water, but you will still have the option of configuring shared heaters and spillover. You can now configure a filter pump and heaters for this body of water.

Are any of Body of Water 2's heaters shared with Body of Water 1?

If Yes is selected:

Which body of water is heated in the event that both are running? Select the Body of Water that you would like to have heating priority if both Bodies of Water are running. This question only appears if you have a Pool/Pool or Spa/Spa setup. If you have a Pool/Spa setup, then the Spa Body of Water will automatically have heating priority.

Select Shared Heater Valves - Select Body of Water 1's return valve, Body of Water 2's return valve, and the Heater return valve in your system. The selections will also affect spillover operation.



HAYWARD®

Select the heaters you wish to share - Select the heaters that you configured in Body of Water 1 that you would like to be shared with Body of Water 2 and press advance.

Does this body of water have any additional heaters? Select whether you have any additional heaters in Body of Water 2 that you would like to configure that are not shared with Body of Water 1.

Do you have Spillover? Select yes to this question if you have Spillover in your system. If yes is selected, choose the valves that will operate Spillover from the following screen.

NOTE: The remaining configuration settings are not specific to a Body of Water.

Do You Have an Air Temperature Sensor? Select whether there is an air temperature sensor wired to the AQR S3 Omni.

If Yes is selected:

Where is the Sensor Wired?

Touching the box will bring you to a table showing all detected sensors connections. Select the sensor connection used for the air sensor (typically SENS2) and touch the Done button. The sensor connection should now be shown in the box and you can advance to the next screen to continue configuration.

Do You Have a Water Temperature Sensor? Select whether there is a water temperature sensor wired to the AQR S3 Omni.

If Yes is selected:

Where is the Sensor Wired?

Touching the box will bring you to a table showing all detected sensors connections. Select the sensor connection used for the water sensor (typically SENS1) and touch the Done button. The sensor connection should now be shown in the box and you can advance to the next screen to continue configuration.

Do You Have a Flow Switch? Select whether there is a flow switch wired to the AQR S3 Omni.

If Yes is selected:

Where is the Sensor Wired?

Touching the box will bring you to a table showing all detected sensors connections. Select the sensor connection used for the (typically FLOW SWITCH 1) and touch the Done button. The sensor connection should now be shown in the box and you can advance to the next screen to continue configuration.

Select and Configure Sensors At this screen you can add, delete and configure your sensors. Select the desired sensor, then touch the Advance button. When finished configuring sensors, you'll be returned to this same screen. Touch the Done button and advance to the next section of configuration. Refer to the following information when configuring sensors:

Where is the Sensor Located? Touch the box and go to the table showing the Bodies of Water and the Backyard. Select the location where the sensor is installed.

What Type of Sensor? Select the type of sensor. Choices are Air, Water, Flow or Solar.

Name Sensor - Touch the box and use the keyboard to name the sensor.



HAYWARD®

Where is the Sensor Wired? Touching the box will bring you to a table showing all detected sensors connections. Select the sensor connection used for the sensor and touch the Done button. The sensor connection should now be shown in the box and you can advance to the next screen to continue configuration.

Do You Want to Configure Any Backyard Lights? Select yes if you are using any type of pool, spa or outdoor lights. The options are Universal ColorLogic (UCL), ColorLogic 4.0 (CL4.0), ColorLogic 2.5 (CL2.5), WaterBowl, Pentair Color LED (P-COLOR), Jandy Color LED (Z-Color), Incandescent, and Other. Transformers powering Universal ColorLogic lights must all be connected to the same high voltage relay for synchronization to function properly. If using Omni Direct mode, you must use an internal relay, not an HLRELAYBANK.

If Yes is selected:

What Kind of Lights? Touch the box to select the type of lights that will be used. Options are UCL (14V), CL4.0 (115V), CL2.5 (14V), WaterBowl, P-Color, Z-Color, Incandescent, and Other.

Name the Group of Lights - Touch the box and use the keyboard to name the lights.

How Many Relays are Lights Wired to? Select the number of relays used by the lights.

Which Relay is it Wired to? Touching the box(es) will bring you to a table showing all detected relays. Select the relay(s) that are connected to the lights and touch the Done button. If the lights are connected to a Smart Power Transformer, select the zone(s) that the lights are wired to. The relay(s) should now be shown in the box(es) and you can advance to the next screen to continue the configuration.

If UCL was previously selected:

Would you like to test for Omni Direct capability? For UCL lights manufactured after June 2018, you can select Yes and the AQR S3 Omni will test your lights to confirm. If your lights blink white after the test, you can enable Omni Direct mode. If not, the UCL light will default to UCL Standalone mode. Note that if you are configuring a WaterBowl light, the Flicker feature will only be available if the light is set to OmniDirect mode.

How Many Accessories are in the Backyard? Select the number of accessories that will be used for the backyard.

If "1" or more is selected:

Select and Configure Accessories At this screen you can add, delete and configure your accessories. Select the desired accessory, then touch the Advance button. When finished configuring accessories, you'll be returned to this same screen. Touch the Done button and advance to the next section of configuration. Refer to the following information when configuring accessories:

Name of Accessory - Touch the box and use the keyboard to name the accessory.

Which Relay is it Wired to? Touching the box will bring you to a table showing all detected relays. Select the relay that is connected to the accessory and touch the Done button. The relay should now be shown in the box and you can advance to the next screen to continue the accessory configuration.

NOTE: Do not use the AQR S3 Omni to control fire pits or any other fire related equipment.



HAYWARD®

Would You Like to Add an Interlock? An interlock will allow the AQR S3 Omni to turn on or off pool equipment (affected) based on the state of other pool equipment (monitored). An example of this is would be the desire to turn on walkway lighting (affected) every time the pool deck lights (monitored) are turned on. This equipment could have been wired together to accomplish the same function, but by interlocking the walkway lights to the deck lights, you'll maintain the ability to turn on the walkway lights independently. An interlock can also control pool equipment based on the state of a temperature sensor, flow switch or external input (normally open/closed switch). An example of this would be to turn on a cabana fan (affected) whenever the outside temperature sensor reads above 90°F. Or, turning on a bug lamp (affected) when a photo sensor (monitored) detects that it is dusk.

If Yes is selected:

Select an Interlock Type - From this screen, select the type of interlock that you would like to configure. The choices are: Equipment to Equipment, Equipment to Sensor, Equipment to Mode, Theme to Sensor, Spillover to External Input and Pool Cover Interlock. Note that interlocks are only selectable if the equipment/features used in that interlock are available. For example, if there are no Themes configured, the Theme to Sensor interlock is not selectable.

If Equipment to Equipment is selected:

To configure the interlock, you'll be asked a series of questions. The questions will vary depending on the equipment that will be configured and cannot all be covered in this manual. In general, you'll select equipment that will be monitored and equipment that will be affected. The equipment could be pumps, valves, heaters, lights, etc. The affected equipment will activate/deactivate depending on the state of the monitored equipment. Advance through the configuration and when finished, a summary screen will be displayed. The summary will describe how the interlocked equipment will function. Read through the description and make sure the equipment will function as desired.

If Equipment to Sensor is selected:

This interlock is similar to above, but the monitored equipment will be a sensor. The monitored sensor can be any sensor, flow switch or external input that has been configured for use with the AQR S3 Omni. The affected equipment will activate/deactivate depending on the state of the monitored sensor. For flow switch sensors, affected equipment will turn on/off when the flow switch detects flow or no flow. For temperature sensors, affected equipment will activate/deactivate when the temperature is higher or lower than a desired setpoint. For external inputs, affected equipment will turn on/off when the switch is actuated. Advance through the configuration and when finished, a summary screen will be displayed. The summary will describe how the interlocked equipment will function. Read through the description and make sure the equipment will function as desired.

If Equipment to Mode is selected:

With Equipment to Mode interlock, affected equipment will activate/deactivate based on which mode the AQR S3 Omni is in; Pool, Spa or Spillover. You can configure this interlock to turn on/off equipment whenever the AQR S3 Omni goes into one of these available modes. Advance through the configuration and when finished, a summary screen will be displayed. The summary will describe how the interlocked equipment will function. Read through the description and make sure the equipment will function as desired.



If Theme to Sensor is selected (at least one Theme must be configured, see Operation Manual):

This interlock is similar to the Equipment to Sensor interlock but a Theme is affected instead. As explained in the Operation manual, Themes are created to execute many pool functions with a single button. With a Theme to Sensor interlock, the Theme will run or stop depending on the state of the monitored sensor. For flow switch sensors, the Theme will run or stop when the flow switch detects flow or no flow. For temperature sensors, the Theme will run or stop when the temperature is higher or lower than a desired setpoint. For external inputs, the Theme will run or stop when the switch is actuated. Advance through the configuration and when finished, a summary screen will be displayed. The summary will describe how the interlocked Theme will function. Read through the description and make sure the equipment will function as desired.

If Spillover to External Input is selected (requires that you have an external input configured):

This interlock prevents Spillover mode when an external input (most commonly a pool cover sensor) is actuated. By interlocking Spillover to the pool cover sensor, you'll ensure that water cannot spill into the pool when the cover is in the closed position. A summary screen will be displayed after configuring this interlock. Read through the description and make sure the interlock will function as desired.

If Pool Cover Interlock is selected (if using an automatic pool cover):

This interlock makes it easy to assign specific pool settings when the cover is closed. Pump speed, heater temperature and chlorination percentage can all be preset for periods when the pool cover sensor (external input) detects that the cover is closed. Some or all of these options may not appear if you don't have a variable speed pump, heater or if not using chlorination. An alternative to this interlock is using a Theme to Sensor interlock. Create a Theme using desired settings when the pool cover is closed, then interlock the Theme to the pool cover sensor. A summary screen will be displayed after configuring this interlock. Read through the description and make sure the interlock will function as desired.



Quick Edit Guide

If additional pool or backyard equipment is added after initial configuration, or you'd like to make a change to an existing configuration setting, re-enter the Configuration Wizard and select "Edit". After selecting "Edit", you will be brought to the Quick Edit Main Menu screen as shown below. Quick Edit allows you to go directly to the equipment that you'd like to add/remove/configure. When you have finished editing the configuration, you will return to this screen to save your changes.

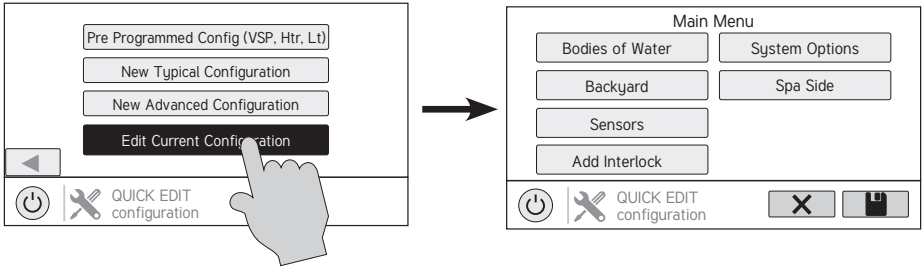

Navigation

There are a number of additional buttons that appear in Quick Edit that either have functions unique to Quick Edit or do not appear anywhere else in the system. These buttons are as follows:



Save - Touch this button to save the configuration edit. This button only appears on the Quick Edit Home screen.



Cancel - Touch this button to cancel any changes made to the configuration and exit Quick Edit. This button only appears on the Quick Edit Home Screen.



Home - Touch this button to quickly jump back to the Quick Edit Main Menu Screen to save your changes. This button appears at the end of every configuration pathway.



Back - Touch this button to go back to the previous set of configurable items.

As you are using Quick Edit, you will notice that at the end of each pathway, a Home button and a back arrow will appear. If you are finished making changes, press the Home button and then press the Save button to save your configuration. If you would like to make more changes to the same device, press the back arrow. This will take you back to the last screen of configurable items for that device. If you would like to continue to make changes, but to a different device, press the Home button and then follow the pathway to the new device. The following pages will explain each configuration pathway.

Begin Using Quick Edit

From the Quick Main Menu Screen, select one of the following buttons and follow the directions on the next page to configure your equipment.

- Bodies of Water
- Backyard
- Sensors
- Interlocks/Add Interlock
- System Options
- Spa Side



HAYWARD®

If Bodies of Water is selected:

Select the body of water - Select the Body of Water that you would like to make changes to. Both bodies of water will have the same equipment options for Quick Edit.

Body of Water is selected:

Select the Equipment that you would like to configure - The options are as follows: Filter Pumps, Heaters, Chemistry, Cleaners, Water Features, Standalone Lights, Accessories, and Other Options. If the equipment is not already configured, then the buttons will appear as Add Heater, Add Chemistry, etc. When the button is pressed with the word "Add" before it, then you will be taken through the full configuration for that equipment as appears in the Configuration Wizard portion of this manual. Otherwise:

If Filter Pumps is selected:

Select a Filter Pump - Once you select a filter pump, all of the options for that filter pump will appear on the next screen. These options are as follows:

Name - Rename the Filter Pump to whatever name you desire.

Type - Change the type of Filter Pump that is configured (Single Speed, 2-Speed, or VSP)

HUA - Match the HUA (Hayward Unique Address) to the configured Filter Pump. This option only appears if the Filter Pump is configured as a Variable Speed Pump.

Speed - Change the Minimum and Maximum Allowed Speeds of the Filter Pump as well as the Low, Medium and High speed settings. This option only appears if the Filter Pump is configured as a Variable Speed Pump.

Relay - Select the relay(s) that the Filter Pump is wired to. This option only appears if the Filter Pump is configured as a single speed or 2-Speed pump.

Off for Valve Change - Select whether you want the Filter Pump to shut off while valves are turning.

Flow Monitoring - Select whether you want flow to be monitored in this Body of Water.

Priming - Select whether you want the Filter Pump to prime and the desired duration. This option only appears if the Filter Pump is configured as a 2-Speed or Variable Speed Pump.

Freeze Protect - Select whether you want the Filter Pump to turn on for Freeze Protection. Also set the Freeze Protect air temperature threshold from this menu. Freeze protect operation can be overridden for a 60 minute period. (See Operation manual for more information).



HAYWARD®

If Heating/Cooling is selected:

Add a Heater - Pressing “Add a Heater” from this screen will take you through the full configuration for adding a new heater. These steps are described in the Advanced Configuration Wizard section of this manual.

Add a Chiller - Pressing “Add a Chiller” from this screen will take you through the full configuration for adding a new chiller. These steps are described in the Configuration Wizard portion of this manual.

General Heater Options - Pressing this button will take you to a screen with the following general options for heater operation:

Extend - If “Enabled”, the filter extend logic keeps the filter pump running beyond the normal turn-off time until the water is heated up to the desired temperature setting. Heater extend will NOT cause the filter pump to turn on, it will only delay the turn off time when the heater is operating.

Cooldown - This feature ensures that the heater cools down before water circulation is stopped. When enabled, the AQR S3 Omni will continue to run the filter pump for 5 minutes after the heater turns off.

Max Temperature - Select the maximum allowed heater setpoint temperature.

Select a Heater/Chiller - Once you select a heater/chiller, all of the options for that heater/chiller will appear on the next screen. These options are as follows:

Name - Create a custom name if desired.

HUA - Select the HUA of the Smart Heater. This option only appears if a Smart Heater is configured.

Type - Select the type of heater that is configured (Solar, Heat Pump, Gas, Geothermal, Electric).

Relay - Select the relay that the heater/chiller is wired to. Option not available for Solar heaters.

Valve - Configure the heating/cooling valve, if used.

Min Filter Speed - Select the minimum speed that the Filter Pump will run while the heater/chiller is active. This option is only available for 2-speed and VSP pumps.

Min Air Temperature - Select the minimum air temperature that the heater will be allowed to run. This option is only available if the heater is configured as a Heat Pump.

Priority Duration - Select the number of hours that this heater/chiller will run before the secondary heater/chiller turns on.



HAYWARD®

Pump - Configure the boost pump for the heater. This option is only available if the heater is configured as a Solar heater.

Valve - Configure the heating valve, if used. This option is only available if the heater is configured as a Solar heater.

Solar Sensor - Configure the solar sensor. This option is only available if the heater is configured as a Solar heater.

Delete a Heater/Chiller - From this screen, if you wish to delete a heater/chiller that is currently configured, select the Delete button can on the right of the name of the heater/chiller that you wish to delete.

If Chemistry is selected:

pH - Once you select pH, all of the options for pH dispensing will appear on the next screen. These options are as follows:

Reduction ON - Select whether you want pH reduction to be enabled.

Chemical Type - Select the type of chemical that is being dispensed (acid or CO₂).

pH Dispensers - Configure the pH dispense unit.

pH Timeout - Choose the pH timeout time.

pH Extend - Select whether you want pH extend enabled for this Body of Water.

Chem Sense Module - Once you select Chem Sense Module, you will be able to select the HUA of your Chem Sense Module you are using from the next screen.

Chlorination - A flow switch must be installed for this function. Once you select Chlorination, all of the options for chlorination will appear on the next screen. These options are as follows:

Dispenser Type - Select the type of dispenser used (T-CELL model, liquid chlorinator or tablet feeder).

Dispenser Relay or Valve - Depending on your dispenser type, select the output that controls the dispenser.

ORP Timeout - Choose the ORP timeout time and desired ORP setpoint. This option is only available if ORP controls chlorination.

Delete Chem Sense Module/Chlorination - From this screen, if you wish to delete any currently configured chemistry options, select the trash can on the right of the name of the item that you wish to delete.



NOTE: If either pH dispensing or chlorination are not configured, then this screen will give you the option to “Add CSM” or “Add Chlorination.” If either of those options are selected, then you will be taken through the full configuration for that equipment as appears in the Configuration Wizard portion of this manual.

If Cleaners is selected:

Add Cleaner - Pressing “Add Cleaner” from this screen will take you through the full configuration for adding a new cleaner. These steps are described in the Configuration Wizard portion of this manual.

Select a Cleaner - Once you select a cleaner, all of the options for that cleaner will appear on the next screen. These options are as follows:

Name - Rename the cleaner to whatever name you desire.

Type - Select the type of cleaner that is configured (Pressure, Suction, Robotic, In Floor).

Pump - Configure the cleaner pump, if used.

Relay - Select the relay that the cleaner is wired to. This option only appears if the cleaner does not have an associated pump configured.

Valve - Configure the cleaner valve, if used.

Freeze Protect - Select whether you want the cleaner to turn on for Freeze Protection. Also set the Freeze Protect air temperature threshold from this menu.

Valve Cycle - Configure the valve cycling time period for the cleaner. This option is only available if the cleaner has an assigned valve.

Speed - Change the Minimum and Maximum Allowed Speeds of the cleaner as well as the Low, Medium and High speed settings. This option only appears if the cleaner pump is configured as a Variable Speed Pump.

Priming - Select whether you want the cleaner pump to prime and the desired duration. This option only appears if the cleaner pump is configured as a 2-Speed or Variable Speed Pump.

Delete a Cleaner - From this screen, if you wish to delete a cleaner that is currently configured, select the trash can on the right of the name of the cleaner that you wish to delete.

If Water Features is selected:

Add Water Feature - Pressing “Add Water Feature” from this screen will take you through the full configuration for adding a new water feature. These steps are described in the Configuration Wizard portion of this manual.



Select a Water Feature - Once you select a water feature, all of the options for that water feature will appear on the next screen. These options are as follows:

Name - Rename the water feature to whatever name you desire.

Type - Change the type of water feature that is configured (Waterfall, Waterslide, etc.).

Pump - Configure the water feature pump, if used.

Relay - Select the relay that the water feature is wired to. This option appears only if the water feature does not have an associated pump configured.

Valve - Configure the water feature valve, if used.

Speed - Change the Minimum and Maximum Allowed Speeds of the water feature pump as well as the Low, Medium and High speed settings. This option only appears if the water feature pump is configured as a Variable Speed Pump.

Priming - Select whether you want the water feature pump to prime and the desired duration. This option is only available if the water feature pump is configured as a 2-Speed or Variable Speed Pump.

Freeze Protect - Select whether you want the water feature to turn on for Freeze Protection. Also set the Freeze Protect air temperature threshold from this menu.

Default Startup Speed - Select the speed that the filter pump will run at when the water feature is turned on.

Delete a Water Feature - From this screen, if you wish to delete a water feature that is currently configured, select the trash can on the right of the name of the water feature that you wish to delete.

If Standalone Lights is selected:

Add Standalone Light - Pressing "Add Standalone Light" from this screen will take you through the full configuration for adding new lights. These steps are described in the Configuration Wizard portion of this manual.

Select an Existing Group of Lights - Once you select a group of existing lights, all of the options for those lights will appear on the next screen. These options are as follows:

Name - Rename the group of lights to whatever name is desired.

Type - Select the type of lights configured.

Relay - Select the relay(s) that the group of lights is wired to. If using a



Smart Power Transformer, select the zone(s) that the lights are wired to.

Set Mode - Set the mode of the lights configured.

Omni Direct - If UCL was previously selected, this button will appear and allow you to test whether your UCL lights are Omni Direct compatible (lights built after June 2018). Note that if you are configuring a WaterBowl light, the Flicker feature will only be available if the light is set to OmniDirect mode.

Delete an Existing Group of Lights - From this screen, if you wish to delete a group of lights that is currently configured, select the group and then select the trash can button next to it.

If Accessories is selected:

Add Accessory - Pressing "Add Accessory" from this screen will take you through the full configuration for adding a new accessory. These steps are described in the Configuration Wizard portion of this manual.

Select an Accessory - Once you select an accessory, all of the options for that accessory will appear on the next screen. These options are as follows:

Name - Rename the accessory to whatever name you desire.

Type - Select the type of accessory configured (Laminar, Water Feature, etc.).

Pump - Configure the accessory pump, if used.

Valve - Configure the accessory valve, if used.

Speed - Change the Minimum and Maximum Allowed Speeds of the accessory pump as well as the Low, Medium and High Speed settings. This option only appears if the accessory pump is configured as a Variable Speed Pump.

Priming - Select whether you want the accessory pump to prime and the desired duration. This option is only available if the accessory pump is configured as a 2-Speed or Variable Speed Pump.

Freeze Protect - Select whether you want the accessory to turn on for Freeze Protection. Also set the Freeze Protect air temperature threshold from this menu.

Relay - Select the relay that the accessory is wired to. This option only appears if the accessory does not have an associated pump configured.

Default Startup Speed - Select the speed that the filter pump will run at when the accessory is turned on.

Delete an Accessory - From this screen, if you wish to delete an accessory that is currently configured, select the trash can on the right of the name of the



HAYWARD®

accessory that you wish to delete.

If Other Options is selected:

Name - This is where you will be allowed to rename the Body of Water that you are currently configuring to whatever name you desire.

If Backyard is selected:

Select the Equipment that you would like to configure - The options are Add Standalone Light and Add Accessory. The configuration for these are described in the Configuration Wizard portion of this manual.

If Standalone Light is selected:

Add Standalone Light - Pressing "Add Standalone Light" from this screen will take you through the full configuration for adding new lights. These steps are described in the Configuration Wizard portion of this manual.

Select an Existing Group of Lights - Once you select a group of existing lights, all of the options for those lights will appear on the next screen. These options are as follows:

Name - Rename the group of lights to whatever name is desired.

Type - Select the type of lights configured.

Relay - Select the relay(s) that the group of lights is wired to. If using a Smart Power Transformer, select the zone(s) that the lights are wired to.

Set Mode - Set the mode of the lights configured.

Omni Direct - If UCL was previously selected, this button will appear and allow you to test whether your UCL lights are Omni Direct compatible (lights built after June 2018). Note that if you are configuring a WaterBowl light, the Flicker feature will only be available if the light is set to OmniDirect mode.

Delete an Existing Group of Lights - From this screen, if you wish to delete a group of lights that is currently configured, select the group and then select the trash can button next to it.

If Accessories is selected:

Add Accessory - Pressing "Add Accessory" from this screen will take you through the full configuration for adding a new accessory to the Backyard. These steps are described in the Configuration Wizard portion of this manual.

Select an Accessory - Once you select an accessory, all of the options for that Backyard accessory will appear on the next screen. These options are as follows:

Name - Rename the accessory to whatever name is desired.

Relay - Select the relay that the accessory is wired to.



HAYWARD®

Delete an Accessory - From this screen, if you wish to delete an accessory that is currently configured, select the trash can on the right of the name of the accessory that you wish to delete.

NOTE: The system does not allow you to configure a pump or a valve to accessory equipment in the Backyard.

If Sensors is selected:

Add Sensor - Pressing "Add Sensor" from this screen will take you through the full configuration for adding a new sensor. These steps are described in the Configuration Wizard portion of this manual.

Select a Sensor - Once you select a sensor, all of the options for that sensor will appear on the next screen. These options are as follows:

Name - Rename the sensor to whatever name is desired.

Location - Select the location that the sensor is wired to.

Delete a sensor - From this screen, if you wish to delete a sensor that is currently configured, select the trash can on the right of the name of the sensor that you wish to delete.

If Interlocks is selected:

Add Interlock - Pressing "Add Interlock" from this screen will take you through the full configuration for adding a new interlock. These steps are described in the Configuration Wizard portion of this manual.

Select an Interlock - Selecting an interlock from this screen will allow you to view that interlock's configuration. However, you cannot edit a pre-existing interlock. In order to change an interlock's configuration, you have to delete the obsolete interlock and create a new one.

Delete an Interlock - From this screen, if you wish to delete an interlock that is currently configured, select the trash can on the right of the name of the interlock that you wish to delete.

NOTE: If there are currently no interlocks configured on your system, then the button will appear as "Add Interlock" instead of "Interlocks". In this case, pressing "Add Interlock" will take you through the full configuration for adding a new interlock. These steps are described in the Configuration Wizard portion of this manual. Once an interlock has been created, the button will say "Interlocks".

If System Options is selected:

Modify Network Setup - Press this button to modify or setup a wired or wireless connection. *Would you like to set up a network connection now?* Select the type of connection you would like to setup/modify or select "Not Now". For external antenna connections, you must have a Hayward HLWLAN connected to the AQR S3 Omni. "Wired" requires an ethernet connection to the router.

Wireless - If not connected to a network, selecting this button will run a scan of all available wifi networks. Select the desired network and enter a password to connect. Note that a 2.4GHz connection to the router is required. If already



connected to a wifi network, selecting this button will present these four options:

Forget Network - This selection allows you to delete saved access points and will prevent the AQR S3 Omni from automatically connecting to the deleted wifi network.

Change Password - This selection will allow you to enter a new wifi password. Use this option if you've changed the wifi password on your router/access point.

Network Properties - Network properties will allow you to set a static ip address for the AQR S3 Omni. The AQR S3 Omni will default to a dynamic ip connection and display current network information such as the local/gateway ip addresses. If a static connection is desired, select "Static" and enter the required network information.

Diagnostic - This selection will re-establish a connection to your wireless network and display current network information such as wifi SSID, signal strength, and the local/gateway ip addresses.

Wired - For a wired connection, run an Ethernet cable from the Controller to the router (page 18). After selecting "Wired", the system will display the ip address and other network properties. Press the check mark and the AQR S3 Omni will verify the network connection. You can now exit back to the main menu and continue with the Configuration Wizard.

External Antenna - Make this selection when setting up a Hayward HLWLAN. Note that a 2.4GHz connection to the router is required. Once the system is done running through the diagnostics, press the check mark to continue to the next section of the Configuration Wizard.

Not Now - Skip network setup and continue with Configuration Wizard.

Mood Color - To alert the user of warning conditions (no flow, failed sensor, etc.), the AQR S3 Omni can change its screen color. The screen can display yellow or red depending on the severity of the condition.

Simple Mode - Use this selection to enable and disable icons to be displayed while in Simple Mode screen. For more information, refer to the Simple Mode section in the Operation manual.

If Spa Side is selected (requires HLSPASIDE):

Spa Side - Press this button to setup or modify a HLSPASIDE remote control.

Select an Aux button to configure - The 3 Aux buttons on the HLSPASIDE can be configured to run equipment, favorites or themes. In some cases, these buttons may be assigned to default functions. To change functions or assign a new function, select the button that you'd like to configure.

If an Aux button is selected:

Select Function - There are 4 options available.



HAYWARD®

Equipment - Pressing this button will bring you to a screen that shows all available equipment. Select the desired equipment that you want to assign to the Aux button.

Favorite - Pressing this button will bring you to a screen that shows all available Favorites. These Favorites had to have been defined prior to configuring the Aux buttons. Select the desired Favorite that you want to assign to the Aux button.

Theme - Pressing this button will bring you to a screen that shows all available Themes. These Themes had to have been defined prior to configuring the Aux buttons. Select the desired Theme that you want to assign to the Aux button

Unconfigured - If set to "Unconfigured", the Aux button will have no function.





HAYWARD®

Control Pad Mounting Template

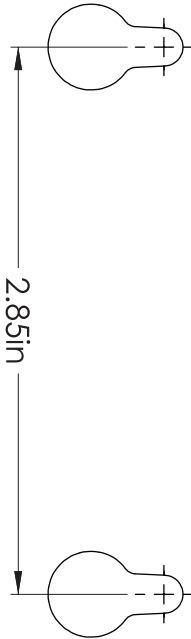



HAYWARD®

LIMITED WARRANTY (effective 03/01/12) Hayward warrants its OmniLogic, OmniHub, Pro Logic, OnCommand and E-Command pool automation products as well as its AquaRite, AquaRite Pro, AquaPlus and SwimPure chlorination products to be free of defects in materials and workmanship, under normal use and service, for a period of three (3) years. Hayward also warrants its Aqua Trol chlorination products to be free of defects in materials and workmanship, under normal use and service for a period of one (1) year. These warranties are applicable from the initial date of purchase on private residential swimming pools in the US and Canada. Installations of product for use on commercial pools in the US and Canada is covered for a period of one (1) year for defects in materials and workmanship. Hayward warrants all accessories and replacement parts for the above-identified pool automation and chlorination products for a period of one (1) year. Accessories also include remotes, actuators, base stations, temperature sensors, flow switches and chemistry probes. Each of these warranties is not transferable and applies only to the original owner.

Hayward shall not be responsible for cartage, removal, repair or installation labor or any other such costs incurred in obtaining warranty replacements or repair.

Proof of purchase is required for warranty service. If written proof of purchase is not provided, the manufacturing date code will be the sole determinant of the date of installation of the product. To obtain warranty service or repair, please contact the place of purchase or the nearest Hayward authorized warranty service center. For more information on authorized service centers please contact the Hayward Technical Service Support Center (61 Whitecap Road, North Kingstown RI, 02852) or visit the Hayward web site at www.hayward.com.

WARRANTY EXCLUSIONS:

1. Material supplied or workmanship performed by others in process of installation.
2. Damage resulting from improper installation including installation on pools larger than the product rating.
3. Problems resulting from failure to install, operate or maintain the product(s) in accordance with the recommendations contained in the owners manual(s).
4. Problems resulting from failure to maintain pool water chemistry in accordance with the recommendations in the owners manual(s).
5. Problems resulting from tampering, accident, abuse, negligence, unauthorized repairs or alternations, fire, flood, lightning, freezing, external water, degradation of natural stone used in or immediately adjacent to a pool or spa, war or acts of God.
6. Use of a non-genuine Hayward replacement salt chlorination cell on any Hayward automation or chlorination product will void the warranty for that product.

The express limited warranty above constitutes the entire warranty of Hayward Pool Products with respect to its products and is in lieu of all other warranties expressed or implied, including warranties of merchantability or fitness for a particular purpose. In no event shall Hayward Pool products be responsible for any consequential, special or incidental damages of any nature. Some states do not allow a limitation on how long an implied warranty lasts, or the exclusion of incidental or consequential damages, so the above limitation may not apply to you. This warranty gives you specific legal rights, and you may also have other rights, which vary from state to state.

For further information or consumer
technical support, visit our website at
www.hayward.com



Hayward is a registered trademark of Hayward Industries, Inc. © 2023 Hayward Industries, Inc.

All other trademarks not owned by Hayward are the property of their respective owners.
Hayward is not in any way affiliated with or endorsed by those third parties.

USE ONLY HAYWARD GENUINE REPLACEMENT PARTS